

CP4220

USER MANUAL

020-100690-02

CP4220

USER MANUAL

020-100690-02

NOTICES

COPYRIGHT AND TRADEMARKS

© 2011 - 2012 Christie Digital Systems USA, Inc. All rights reserved.

All brand names and product names are trademarks, registered trademarks or trade names of their respective holders.

REGULATORY

The product has been tested and found to comply with the limits for a Class A digital device, pursuant to Part 15 of the FCC Rules. These limits are designed to provide reasonable protection against harmful interference when the product is operated in a commercial environment. The product generates, uses, and can radiate radio frequency energy and, if not installed and used in accordance with the instruction manual, may cause harmful interference to radio communications. Operation of the product in a residential area is likely to cause harmful interference in which case the user will be required to correct the interference at the user's own expense.

This Class A digital apparatus complies with Canadian ICES-003.
Cet appareil numérique de la classe A est conforme à la norme NMB-003 du Canada.

이 기기는 업무용 (A 급) 으로 전자파적합등록을 한 기기이오니 판매자 또는 사용자는 이점을 주의하시기 바라며, 가정 외의 지역에서 사용하는 것을 목적으로 합니다.

GENERAL

Every effort has been made to ensure accuracy, however in some cases changes in the products or availability could occur which may not be reflected in this document. Christie reserves the right to make changes to specifications at any time without notice. Performance specifications are typical, but may vary depending on conditions beyond Christie's control such as maintenance of the product in proper working conditions. Performance specifications are based on information available at the time of printing. Christie makes no warranty of any kind with regard to this material, including, but not limited to, implied warranties of fitness for a particular purpose. Christie will not be liable for errors contained herein or for incidental or consequential damages in connection with the performance or use of this material.



The product is designed and manufactured with high-quality materials and components that can be recycled and reused. This symbol means that electrical and electronic equipment, at their end-of-life, should be disposed of separately from regular waste. Please dispose of the product appropriately and according to local regulations. In the European Union, there are separate collection systems for used electrical and electronic products. Please help us to conserve the environment we live in!

Canadian manufacturing facility is ISO 9001 and 14001 certified.

GENERAL WARRANTY STATEMENTS

For complete information about Christie's limited warranty, please contact your Christie dealer. In addition to the other limitations that may be specified in Christie's limited warranty, the warranty does not cover:

- a. Damage occurring during shipment, in either direction.
- b. Projector lamps (See Christie's separate lamp program policy).
- c. Damage caused by use of a projector lamp beyond the recommended lamp life, or use of a lamp supplied by a supplier other than Christie.
- d. Problems caused by combination of the product with non-Christie equipment, such as distribution systems, cameras, video tape recorders, etc., or use of the product with any non-Christie interface device.
- e. Damage caused by misuse, improper power source, accident, fire, flood, lightning, earthquake or other natural disaster.
- f. Damage caused by improper installation/alignment, or by product modification, if by other than a Christie authorized repair service provider.
- g. For LCD projectors, the warranty period specified applies only where the LCD projector is in "normal use." "Normal use" means the LCD projector is not used more than 8 hours a day, 5 days a week. For any LCD projector where "normal use" is exceeded, warranty coverage under this warranty terminates after 6000 hours of operation.
- h. Failure due to normal wear and tear.

PREVENTATIVE MAINTENANCE

Preventative maintenance is an important part of the continued and proper operation of your product. Please see the Maintenance section for specific maintenance items as they relate to your product. Failure to perform maintenance as required, and in accordance with the maintenance schedule specified by Christie, will void the warranty.

1: Introduction

1.1 Labels and Markings 1-1
1.2 AC / Power Precautions..... 1-2
1.3 Lamp Precautions 1-2
1.4 Contact Your Dealer 1-3

2: Installation and Setup

2.1 Site Requirements..... 2-1
2.2 Tools Required for Installation..... 2-1
2.3 Projector Components 2-2
2.4 Installation Safety and Warning Guidelines..... 2-5
2.5 Position the Projector..... 2-5
2.6 Adjust Tilt and Level the Projector 2-6
2.7 Install the Touch Panel Controller (TPC)..... 2-7
2.8 Connect External Exhaust Ducting..... 2-8
 2.8.1 Determine the Projector Exhaust CFM Value 2-8
2.9 Remove the Shroud 2-9
2.10 Install the Primary Lens..... 2-9
2.11 Install the Optional Anamorphic Lens..... 2-12
2.12 Install the Optional Wide Converter Lens..... 2-12
2.13 Install the Lamp..... 2-13
2.14 Connect the Projector to AC Power with a Permanent Connection 2-14
2.15 Connect the Projector to AC Power with a Pluggable Type B Connection 2-16
2.16 Configure the Optional Uninterrupted Power Supply 2-17
2.17 Connect Sources and Turn the Projector On 2-17

3: Connect Devices to the Projector

3.1 Connect a Computer or Server 3-3
3.2 Connecting Devices to the SCCI Port 3-4
3.3 Connecting Devices to the GPIO Port..... 3-5
3.4 Connecting Devices to the 3D Connector 3-7

4: Adjust the Image

4.1 Maximize Light Output 4-1
4.2 Calibrate Screen Brightness (fL) 4-1
4.3 Basic Image Alignment 4-1
4.4 Adjust Offset..... 4-2
4.5 Adjust Offset with an ILS..... 4-2
4.6 Adjust Left and Right Boresight..... 4-3
4.7 Adjust Top and Bottom Boresight..... 4-4
4.8 Adjust Top and Bottom Boresight with an ILS..... 4-5
4.9 Adjust DMD Convergence 4-6
4.10 Fold Mirror Adjustment..... 4-6
4.11 Calibrating the System..... 4-7
4.12 Color Calibration 4-7

Table of Contents

4.13 Electronic Screen Masking	4-7
4.14 Working with 3D	4-7
4.14.1 Display Requirements	4-7
4.14.2 Hardware Setup	4-8
4.14.3 Install a 3D Server with an YCxCz Interface	4-8
4.14.4 Edit the Default 3D Lamp File	4-9
4.14.5 Define a Measured Color Gamut Data File	4-9
4.14.6 Edit the 3D Flat 1998 x 1080 Channel	4-9
4.14.7 Edit the 3D Scope 2048 x 858 Channel	4-10
4.14.8 Display 3D Diagnostic Test Patterns	4-10
4.14.9 Verify 3D Cinema Content	4-14
4.14.10 3D Troubleshooting	4-14

5: Projector Operation

5.1 Turn the Projector On	5-1
5.2 Turn the Projector Off	5-1
5.3 Projector Power States	5-1
5.4 Projector LED Status Indicators	5-2
5.5 Work with the Lamp	5-2
5.5.1 Turning the Lamp On	5-2
5.5.2 Turn the Lamp Off	5-2
5.5.3 Adjust Lamp Power	5-2
5.5.4 Change the Lamp Power Percentage	5-3
5.5.5 Use LampLOC™ to Adjust the Lamp Position	5-3
5.5.6 Manually Adjust the Lamp Position	5-3
5.5.7 View Lamp Information	5-3
5.5.8 Receive an Alarm when a Lamp Reaches Its Expiry Date	5-3
5.5.9 Receive an Alarm when a Lamp Needs to be Rotated	5-4
5.5.10 Lamp Expiry Hours	5-4
5.5.11 Minimum and Maximum Lamp Power Ratings	5-4
5.6 Work with Lenses	5-5
5.6.1 Enable Automatic ILS Selected	5-5
5.6.2 Enable Automatic ILS NOT Selected	5-6
5.6.3 Access the ILS	5-6
5.6.4 Enable ILS on a Channel	5-6
5.6.5 Alter the Active ILS Settings	5-7
5.6.6 Maintain Lens Position Regardless of Selected Channel	5-7
5.6.7 Reset the ILS	5-7
5.6.8 Calibrate the ILS	5-7
5.7 Present Movies	5-7
5.7.1 Connecting Sources	5-8
5.7.2 Using an Anamorphic Lens	5-8
5.7.3 Using a Wide Converter Lens	5-8
5.7.4 Masking	5-9
5.8 Display Non-Cinema Content	5-9
5.9 Selecting a Source	5-9

6: Projector Menus

6.1 The Touch Panel Controller (TPC) 6-1

6.2 Main Screen 6-2

6.3 Open the On Screen Keyboard 6-4

6.4 User Access and Rights 6-5

6.5 Status Window 6-7

6.6 Alarm Window 6-11

6.7 Interrogator Window 6-12

6.8 SMPTE Errors Window 6-13

6.9 System Logs Window 6-14

6.10 Server Test Window 6-15

6.11 DLP Management Window 6-16

6.12 Network Devices 6-17

6.13 Channel Setup Windows 6-18

 6.13.1 Config 1 Window 6-19

 6.13.2 Config 2 Window 6-20

 6.13.3 3D Control Window 6-21

6.14 Advanced Setup Windows 6-24

 6.14.1 Lamp Power / LiteLOC™ Setup Window 6-25

 6.14.2 Lamp History Window 6-26

 6.14.3 LampLOC™ Setup Window 6-27

 6.14.4 ILS File Setup Window 6-29

 6.14.5 Lens Setup Window 6-30

 6.14.6 Source File Setup Window 6-31

 6.14.7 Screen File Setup Window 6-32

 6.14.8 MCGD File Setup Window 6-33

 6.14.9 TCGD File Setup Window 6-34

6.15 Administrator Setup Windows 6-35

 6.15.1 System Access Window 6-35

 6.15.2 Preferred Channel Setup Window 6-36

 6.15.3 Preferred Test Pattern Setup Window 6-37

 6.15.4 Preferences Window 6-38

 6.15.5 Content Devices Configuration Window 6-39

 6.15.6 Time Setup Window 6-40

 6.15.7 Scheduler Window 6-41

 6.15.8 Communications Configuration Window 6-42

 6.15.9 Network Devices Setup Window 6-43

 6.15.10 GPIO Setup Window 6-44

 6.15.11 Foot Lamberts Calibration Window 6-45

 6.15.12 User Accounts Window 6-46

 6.15.13 Upgrade Window 6-48

6.16 Service Setup Windows 6-49

 6.16.1 File Management Window 6-50

 6.16.2 Marriage Window 6-51

 6.16.3 Digital Convergence Window 6-52

Table of Contents

6.16.4 System Access Window 6-53
 6.16.5 IMB Marriage Window 6-54
 6.16.6 Lamp Power Supply Setup Window 6-55
 6.17 About Window 6-56
 6.18 Help Window 6-57

7: Maintenance

7.1 Inspect Ventilation 7-1
 7.2 Fill the Coolant Reservoir 7-1
 7.3 Inspect the Lamp 7-1
 7.4 Inspect and Clean Optics 7-2
 7.4.1 Clean the Lens 7-2
 7.5 Inspect and Clean the Lamp Blower 7-2
 7.6 Clean the Igniter 7-3
 7.7 Inspect and Clean the Airflow Interlocks 7-3
 7.8 Inspect the Laminar Airflow Device (LAD) 7-3
 7.9 Replace the Lamp 7-3
 7.10 Rotate the Lamp 7-6
 7.11 Replace the Light Engine Air Filter 7-6
 7.12 Replace the Liquid Cooling Air Filter 7-7
 7.13 Replace the Lens 7-7

8: Troubleshooting

8.1 Projector Does Not Turn On 8-1
 8.2 Lamp Does Not Ignite 8-1
 8.3 Lamp Suddenly Turns Off 8-2
 8.4 Flicker, Shadows, Or Dimness 8-2
 8.5 LampLOC™ Not Working 8-2
 8.6 LiteLOC™ Not Working 8-2
 8.7 Touch Panel Controller (TPC) 8-3
 8.8 Trouble Establishing Communication with Projector 8-3
 8.9 Blank Screen, No Display of Cinema Image 8-3
 8.10 Severe Motion Artifacts 8-3
 8.11 Image Appears Vertically Stretched or ‘Squeezed’ into Center of Screen 8-3
 8.12 No Image, Just Pink Snow 8-3
 8.13 Inaccurate Display Colors 8-4
 8.14 Display is Not Rectangular 8-4
 8.15 Display is Noisy 8-4
 8.16 Display has Suddenly Frozen 8-4
 8.17 Data is Cropped from Edges 8-4
 8.18 The Projector is ON, but There is No Image 8-4
 8.19 The Display is Jittery or Unstable 8-6
 8.20 The Display is Faint 8-6
 8.21 Portions of the Display are Cut OFF or Warped to the Opposite Edge 8-6
 8.22 Display Appears Compressed (Vertically Stretched) 8-6

8.23 Inconsistent Picture Quality..... 8-6

A: Specifications

A.1 Display A-1

- A.1.1 Panel Resolution and Refresh Rate A-1
- A.1.2 Achievable Brightness (Measured at Screen Center) A-1
- A.1.3 Achievable Contrast Ratio A-1
- A.1.4 Color and Gray Scale A-1
- A.1.5 White Point A-1
- A.1.6 Gamma A-1

A.2 Source Signal Compatibility A-1

- A.2.1 Cinema Inputs A-1
- A.2.2 Non-Cinema DVI Inputs (for Alternate Content) A-4

A.3 Control Signal Compatibility A-5

- A.3.1 Ethernet Port A-5
- A.3.2 RS232-PIB A-5
- A.3.3 RS232-ICP A-5
- A.3.4 GPIO Port A-5
- A.3.5 Simple Contact Closure Interface (SCCI) Port A-5
- A.3.6 3D Port A-6
- A.3.7 USB 1 Port A-6
- A.3.8 USB 2 Port A-6
- A.3.9 MALM (located on Auxiliary Input Panel) A-6

A.4 Touch Panel Controller A-6

A.5 Power Requirements A-7

- A.5.1 AC Input A-7
- A.5.2 UPS AC Input A-7

A.6 Lamp A-7

A.7 Physical Specifications A-8

A.8 Regulatory A-8

- A.8.1 Safety A-8
- A.8.2 Electro-Magnetic Compatibility A-8

A.9 Environment A-9

- A.9.1 Operating Environment A-9
- A.9.2 Non-Operating Environment A-9

A.10 Accessories A-9

- A.10.1 Standard (sold with product) A-9
- A.10.2 Accessories (sold separately) A-9
- A.10.3 Other Accessories (sold separately) A-10

B: Serial API

B.1 Function Codes B-1

1 Introduction

This manual is intended for professionally trained operators of Christie high-brightness projection systems. These operators are qualified to replace the lamp and air filter, but should not attempt to install or service the projector.

Only accredited Christie technicians who are knowledgeable about the hazards associated with high-voltage, ultraviolet exposure, and the high temperatures generated by the projector lamp are authorized to assemble, install, and service the projector.

1.1 Labels and Markings

These warning labels can appear on the projector:

⚠ DANGER Indicates a hazardous situation which that could result in death or serious injury.

⚠ WARNING Indicates a hazardous situation which, if not avoided, could result in death or serious injury.

⚠ CAUTION Indicates a hazardous situation that could result in minor or moderate injury.

NOTICE! *Addresses practices not related to personal injury.*

⚠ WARNING Never look directly into the projector lens or at the lamp. The extremely high brightness can cause permanent eye damage. For protection from ultraviolet radiation, keep all projector housings intact during operation. Protective safety gear and safety goggles are recommended when servicing.

⚠ WARNING FIRE HAZARD! Keep hands, clothes, and all combustible material away from the concentrated light beam of the lamp.

⚠ CAUTION Position all cables where they cannot contact hot surfaces or be pulled or tripped over.

⚠ CAUTION 1) The American Conference of Governmental Industrial Hygienists (ACGIH) recommends occupational UV exposure for an 8-hour day to be less than 0.1 microwatts per square centimeters of effective UV radiation. An evaluation of your workplace is advised to assure employees are not exposed to cumulative radiation levels exceeding the government guidelines for your area. 2) Be aware that some medications are known to increase sensitivity to UV radiation.



1.2 AC / Power Precautions

To correctly install this projector, a certified electrician must install a permanent a single-phase connection from the projector to the AC supply. You must operate the projector at the recommended voltage.

⚠ WARNING

Disconnect projector from AC before opening any enclosure.

⚠ CAUTION

- 1) **DO NOT** allow anything to rest on the power cord. Locate the projector where the cord cannot be damaged by people walking on it or by objects rolling over it. Never operate the projector if the power cable appears damaged in any way.
- 2) **DO NOT** overload power outlets and extension cords as this can result in fire or shock hazards.
- 3) Note that only qualified service technicians are permitted to open any enclosure on the product and only if the AC has been fully disconnected from the product.

Power Cords and Attachments

⚠ WARNING 1) The North American rated line cord is provided with each projector. Ensure that you are using a power cord, socket and power plug that meets the appropriate local rating standards. 2) Use only an AC power cord recommended by Christie. Do not attempt operation if the AC supply and cord are not within the specified voltage and power range.

Use only the attachments and/or accessories recommended by Christie. Use of others may result in the risk of fire, shock or personal injury.

1.3 Lamp Precautions

Lamps used in the projector are under high pressure and you must handle them with caution. Lamps can explode and cause serious personal injury if they are dropped or mishandled.

⚠ DANGER EXPLOSION HAZARD! Wear authorized protective safety clothing whenever the lamp door is open.

Recommended protective clothing includes, but may not be limited to a polycarbonate face shield, protective gloves, and a quilted ballistic nylon jacket or a welder's jacket. This equipment is included in included in the Christie Protective Clothing Safety Kit #598900-095.

NOTE: Christie's protective clothing recommendations are subject to change. Any local or federal specifications take precedence over Christie recommendations.

⚠ DANGER Lamp may explode causing bodily harm or death. 1) Always wear protective clothing whenever the lamp door is open or while handling lamp. 2) Ensure those within the vicinity of the projector are also equipped with protective clothing. 3) Never attempt to access the lamp while the

lamp is on. Wait a minimum of 10 minutes after the lamp turns OFF before turning the projector off, disconnecting it from a power source, and opening the lamp door.

The arc lamp operates at a high pressure that increases with temperature. Failure to allow the lamp to sufficiently cool prior to handling increases the potential for an explosion causing personal injury or property damage.

1.4 Contact Your Dealer

If you encounter a problem with your Christie projector, contact your dealer. To assist with the servicing of your projector, enter the information in the tables and keep this information with your records.

Table 1.1 Purchase Record

Dealer:
Dealer or Christie Sales/Service Contact Phone Number:
Projector Serial Number*:
Purchase Date:
Installation Date:

** The serial number is on the license label located on the front panel of the projector.*

Table 1.2 Ethernet Settings

Default Gateway	
Projector IP Address	
Subnet Mask	

2 Installation and Setup

This section explains how to install, connect, and optimize the projector display.

2.1 Site Requirements

To safely install and operate the CP4220 projector, the installation location must meet these minimum requirements:

- **Physical Operating Environment**
 - Maximum Ambient Temperature (operating) 35°C
 - Minimum Ambient Temperature (operating) 10°C
- **External Exhaust Ducting**
 - The installation site must provide a minimum of 450 CFM (ft³/min) external exhaust airflow to ensure adequate cooling of the Xenon arc lamp at less than or equal to 25°C ambient and less than 3,000 feet elevation. Above 25°C or 3,000 feet, 600 CFM is required. For detailed instructions for measuring CFM, *see 2.8 Connect External Exhaust Ducting, on page 2-8.*
- **Permanent Power Connection**
 - Single-phase projector unit: Maximum 15A circuit breaker protection provided as part of the building installation
 - Three-phase Lamp Power Supply (LPS): Minimum 50A breaker protection must be provided and must disconnect all phases simultaneously for the stationary permanently connected equipment.
 - Protection from overcurrents, short circuits, and earth faults must be part of the building installation.
 - 4-wire to Terminal Block in Lamp Power Supply (certified electrician required).
 - Protection from overcurrents, short circuits, and earth faults must be part of the building installation. The disconnect device (double pole switch or circuit breaker with minimum 3mm contact gap) must be readily accessible within the projection room.

2.2 Tools Required for Installation

You need these tools to install the CP4220 projector:

- 12" screwdrivers: Phillips #2 (magnetic) and flat
- 19mm and 7/8" wrenches
- Assorted Allen keys (metric)
- Heat extractor
- Christie approved protective safety clothing if you are working with the lamp
- Lamp
- Lens cleaning tissue and solution

2.3 Projector Components

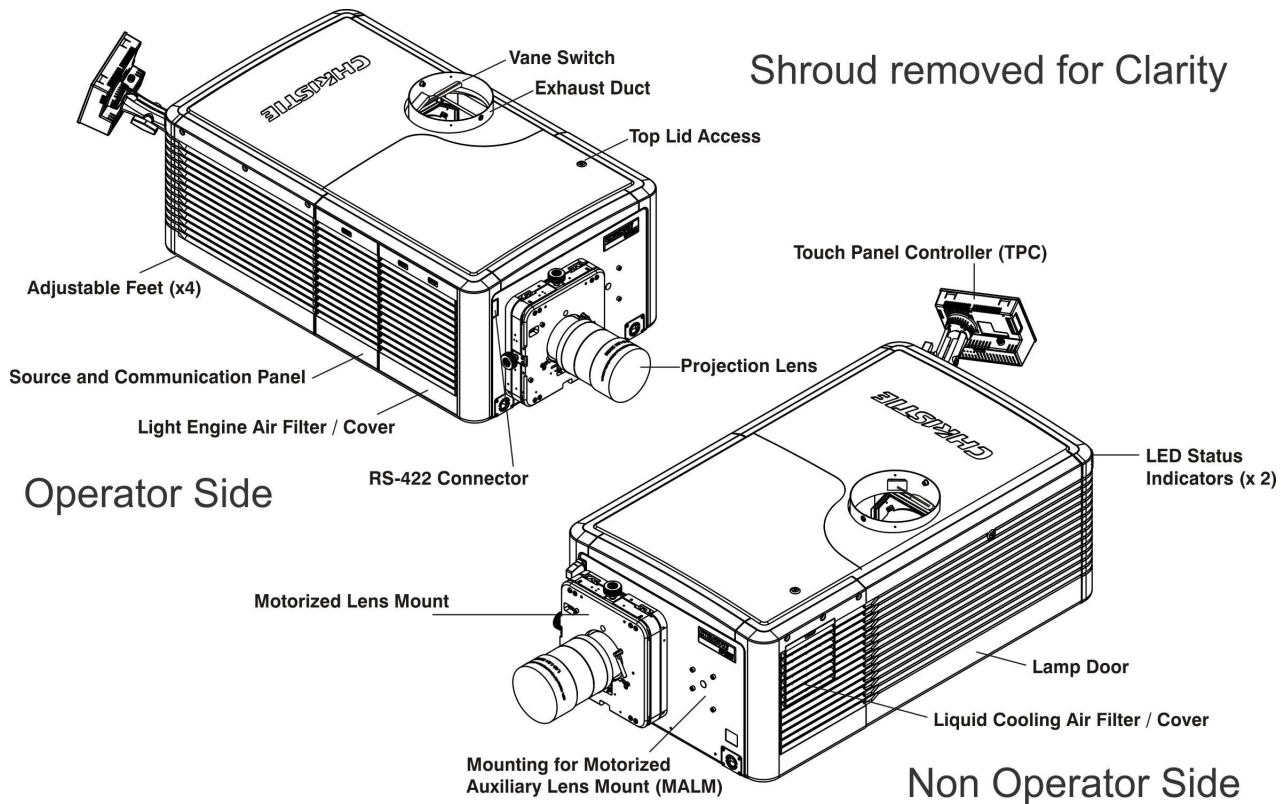


Figure 2-1 Projector Overview

Air Filter Cover and Air Filter

The air filter filters the intake air before it circulates in the front compartment to cool the main electronics. See [Section 7.11 Replace the Light Engine Air Filter](#).

Manual Douser Override

Closes the douser. Closing the douser rotates a shutter blade in front of the lamp and reduces lamp power to 2kW to conserve lamp life. The override switch is meant for emergency use only.

Exhaust Duct and Vane Switch

Extracts heated air from the lamp compartment. The vane switch inside the rigid port monitors the amount of airflow. See [Section 2.1 Site Requirements](#) for airflow requirements of the external heat extraction system.

Adjustable Feet

Adjusts the tilting angle of the projector.

Lamp Door and Lamps

Provides access to the lamp. The lamp door must remain closed and locked for normal operation. Lamp replacement should only be performed by qualified technicians.

The projector 7kW ballast is designed to operate with 2.0kW, 3.0kW, 4.5kW or 6.0kW lamps. See [Section Appendix A: Specifications](#) for a complete list of available lamp types.

LED Status Indicators

Provides information about the status of the projector. See Section 5 Projector Operation for information about projector status

Motorized Auxiliary Lens Mount (MALM)

An optional auxiliary lens mount can be installed adjacent to the primary lens mount to provide motorized positioning of a 1.25x Anamorphic lens or a 1.26 Wide Converter lens in front of the primary lens. The Wide Converter lens “zooms” the image from flat to scope image formats. The Anamorphic lens horizontally spreads the image back into its wider 2.39:1 “scope” image and is most typically used in side-masking theatres or on larger screen sizes.

Projection Lens

A variety of lenses can be used with the CP4220 projector. See [Section Appendix A: Specifications](#) for a list of available lenses.

RS-422 Connector

Connects the motorized lens mount to the projector.

Security Locks

Prevents unauthorized access to projector components.

Shroud

Covers the motorized lens mount assembly. The shroud is to be removed for installing a lens, MALM or when using some 3D equipment.

Input Panel

Connects the projector to external devices such as cinema servers, computers, and controllers.

PIB (Projector Intelligence Board) Faceplate Connections:

10Base-T/100Base-TX Ethernet: Connects the projector to a network.

GPIO: Connects the projector to external Input and output devices, such as the Christie ACT. See [Section 3.3 Connecting Devices to the GPIO Port](#) for GPIO pinouts.

DVI-A / DVI-B: Connects the projector to non-cinema video and graphics sources. These are single-link ports for single-link cables and connectors. The connectors can be used together as a twin-link DVI port.

HD-SDI A/HD-SDI-B: Connects the projector to high-definition cinema sources. The connectors can be used together to deliver Dual Link HD-SDI following the SMPTE 372M standard.

SCCI: A Simple Contact Closure Interface (SCCI) port that uses a simple dry contact closure to turn the lamp on or off or to open or close the douser. See [Section 3.2 Connecting Devices to the SCCI Port](#) for SCCI pinouts.

RS232 ICP: Connects a projector to a computer for direct DLP communication.

RS232 PIB: Connects the projector to Christie accessories or third-party automation equipment.

Marriage: Allows the projector to display encrypted content.

Emergency Start: Starts the projector, turns the lamp on, and opens the douser when the Touch Panel Controller is unavailable or disconnected. Press and hold this button, to close the douser and turn the lamp off; the power remains on.

Reset: Resets the projector electronics. If the projector is in standby mode, it returns to standby mode after the reset. If the projector is in any other state, the projector is on and the lamp is off following the reset.

3D: Connects the projector to 3D products, such as MasterImage or Real D for polarizing and de-ghosting 3D content during projection.

ICP Faceplate Connections

The ICP board provides the image processing electronics for the projector. The ICP faceplate includes a number of LEDs that are only functional when the projector is in full power mode.

- **REGEN:** (Regulators Enabled) Indicates the presence of the internal regulator enable signal. When illuminated BLUE the internal regulators are enabled. When OFF, not enabled.
- **SOFTST:** (Software State) Indicates the state of the software application. When OFF, in a Fail state (0). When RED, in a Fail state (1). When YELLOW, in a Fail state (2). When GREEN, status OK.
- **OSST:** (Operating System State) Indicates the state of the operating system. When OFF, in a Fail state (0). When RED, in a Fail state (1), When YELLOW, in a Fail state (2). When GREEN, status OK.
- **FMTST:** (FMT FPGA State) Indicates the configured state of the FMT FPGA. When RED, unable to configure FPGA with Main or Boot application. When YELLOW, in Boot application. When Green, in Main application.
- **ICPST:** (ICP FPGA State) Indicates the configured state of the ICP FPGA. When RED, unable to configure FPGA with Main or Boot application. When YELLOW, in Boot application. When Green, in Main application.
- **Port A / Port B:** Indicates the status of the ICP input port A or B. When OFF, no source is present. When GREEN, an active source is present.
- **IMB:** Allows the installation of an Image Media Block (IMB).

Touch Panel Controller (TPC)

The TPC is a touch-sensitive screen that you use to control the projector. It is mounted on the rear of the projector and you can use the flexible connection to adjust the viewing angle. In general, the TPC provides users with a means for monitoring operation and status of the projector. You typically use the TPC to turn the lamp on or off, select an input device, and view status information.

You can install the TPC on a wall near the projector, or you can use the optional extension cable to control the projector from a maximum distance of 100 feet.

2.4 Installation Safety and Warning Guidelines

⚠ WARNING QUALIFIED TECHNICIAN REQUIRED for all installations. This product must be installed in a restricted access location.

⚠ WARNING Never operate the projector without the covers in place.

⚠ WARNING The projector uses a high-pressure lamp that may explode if improperly handled. Always wear manufacturer approved protective safety clothing (gloves, jacket, face shield) whenever the lamp door is open or when handling the lamp. Only qualified technicians should install projector lamps.

⚠ WARNING To prevent the projector from tipping unexpectedly, you must install the safety strap on the rear of the projector.

⚠ WARNING Four or more people are required to safely lift and carry one projection head a short distance. Remove the lamp before transporting the projector.

⚠ CAUTION Keep the projector level when you lift or transport it. Avoid tilting the projector to the right. This can introduce an air bubble into the coolant hoses that can result in an air lock and the overheating of the projector.

⚠ CAUTION Perform a automatic LampLOC™ adjustment when you move, level, or install a new lamp in the projector.

2.5 Position the Projector

1. Position the projector at an appropriate throw distance (projector-to-screen distance) and vertical position. Ideally, center the projector with the theatre screen. If space is limited, aim the projector slightly off-center as shown in **Figure 2-2**. This increases side keystoneing, but reduces the horizontal lens offset required.

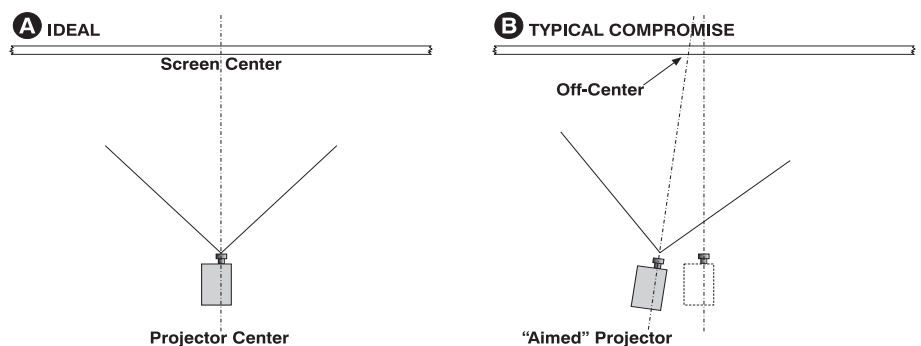


Figure 2-2 Position the Projector

2. Attach the supplied safety strap to the back of the projector and fasten it to its mounting surface. Use of the strap is mandatory to prevent the projector from tipping when a lens or auxiliary lens mount is installed.

NOTE: Unlike film projectors, it is best to keep the projector lens surface as parallel to the screen as possible, even if significantly above the screen center. When a particularly short throw distance combines with a very wide screen, you may have to forfeit some aim and stay more parallel to the screen. In such cases, some lens offset can reduce the keystone distortion.

2.6 Adjust Tilt and Level the Projector

⚠ WARNING The projector's rear safety strap must be in place before you adjust the projector's feet.

⚠ WARNING DO NOT over-extend the feet. Make sure several threads are engaged into the projector's baseplate.

The CP4220 lens should be centered and parallel with the screen. This orientation ensures optimum lens performance with minimal offset. If this position is not possible (such as when the projector is significantly higher than the center of the screen), it is better to rely on offset rather than extra tilt.

Use a protractor to measure the degree of screen tilt and then extend or retract the projector feet to match this angle.

NOTE: *The front-to-back tilt of the projector must not exceed 15°. This limit ensures safe lamp operation and the proper positioning of the liquid cooling reservoir*

To adjust the vertical or horizontal position of the projector, extend or retract the adjustable feet on the bottom of the projector by rotating them. Once the required adjustment is made, tighten the lock nut.

If you need to adjust the vertical or horizontal position of the projector beyond what the standard feet allow, you can install two 6 inch extension rods to increase the amount of adjustment. To install the extension rods safely:

1. Prop the rear of the projector up to access and remove the two rear feet. This can be done by one person holding the back end of the projector up slightly so another person can unthread the feet OR by propping up the back of the projector with a sturdy object.
2. Add the extension rods to the standard feet.
3. Thread the newly extended feet back into the projector's baseplate. Adjust the feet until the desired tilt is achieved.
4. Lock the feet in place by turning each lock nut until it fits tight against the projector.

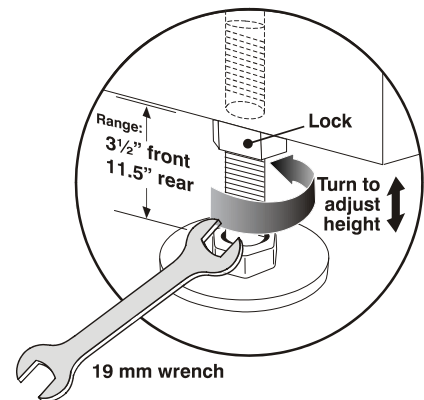


Figure 2-3 Adjust Feet

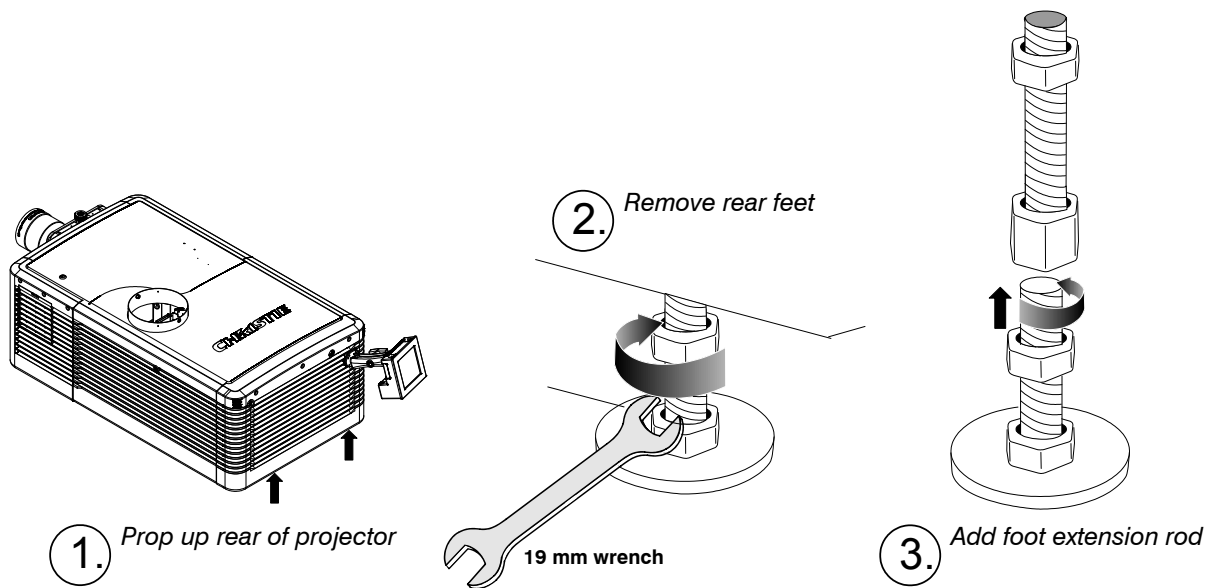


Figure 2-4 Using the Foot Extension Rods

2.7 Install the Touch Panel Controller (TPC)

1. Loosen the mounting arm so that the end fits over the ball joint located on the rear panel of the projector.

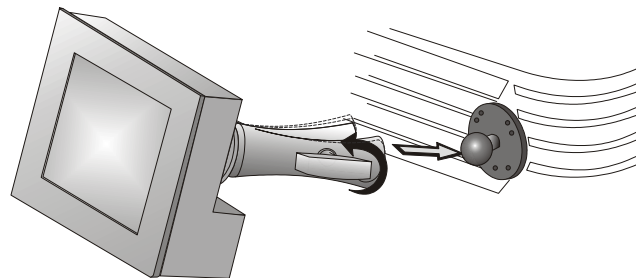


Figure 2-5

2. Tighten the mounting arm until it fits tightly on the joint.

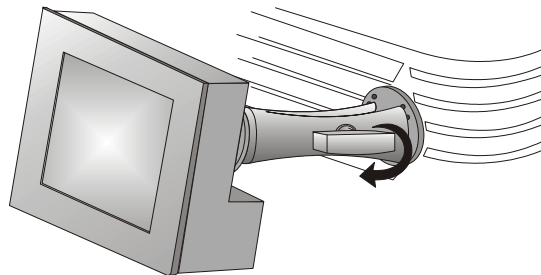


Figure 2-6

3. Connect the cable from the TPC to the connector on the rear panel of the projector.
4. Adjust the angle of the TPC.

2.8 Connect External Exhaust Ducting

Connect the existing outside-venting ductwork to the 8 inch diameter exhaust port on the top of the projector. Confirm that there are no obstructions or bends in the ducting, all air intakes are free of obstructions, and the vane switch at the exit duct moves freely.

The pre-installed outside-venting duct should be rigid at the projector and must also include a heat extractor and blower that maintains a minimum of 450 CFM* when the projector is operating at less than or equal to 25°C ambient and less than 3,000 feet, when measured at the projector exhaust opening.

⚠ WARNING

- ***600 CFM is required in projection rooms with an ambient temperature above 25°C or located at an elevation greater than 3000 feet above sea level.**
- **At minimum, a 10" long, strong metal duct must be installed at the projector to prevent glass shards from exiting the duct in the event of a lamp explosion.**

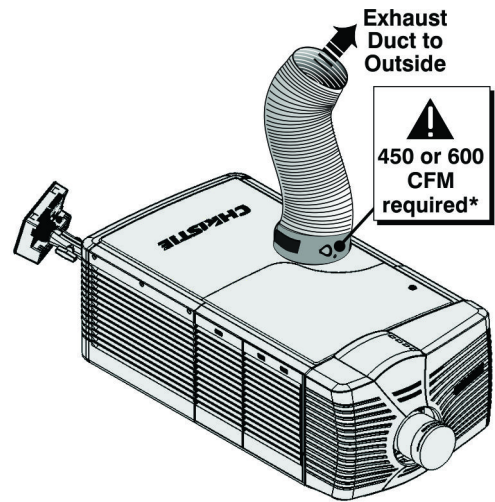


Figure 2-7 Connect Exhaust Ducting

2.8.1 Determine the Projector Exhaust CFM Value

Use an airflow meter to measure the ft/min or ft/sec at the rigid end of the open exhaust duct that connects to the projector. Take the measurement at the very end of the duct without the projector connected. Use this formula to determine the CFM value for the projector:

$$\text{Measured linear ft/min} \times 0.35 = \text{CFM}$$

Table 2.1 Airflow Requirement

Lamp Type	Min. Airflow (CFM) Required
2.0 kW	450 CFM*
3.0 kW	450 CFM*
4.5 kW	600 CFM
6.0 kW	600 CFM

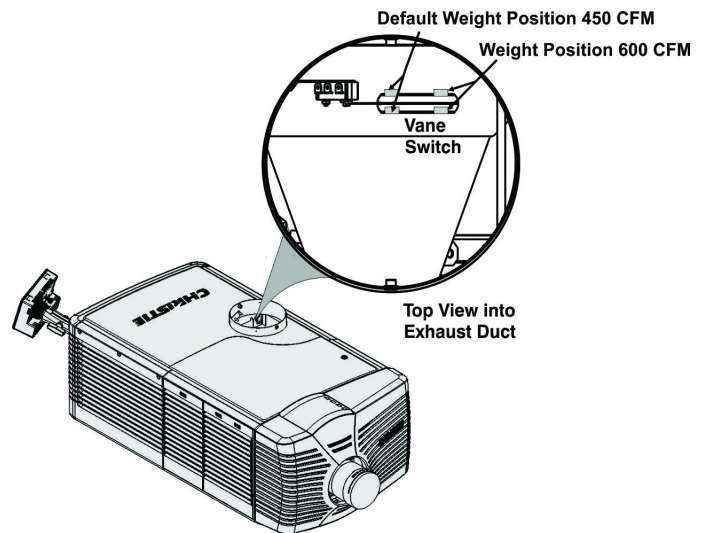


Figure 2-8 Exhaust Duct Vane Switch

Add an extractor or a booster if there is insufficient airflow. Do not mount the extractor on the projector as this may introduce some vibration into the image. **NOTE:** To prevent the projector from overheating or becoming unsafe, an alarm sounds if the duct is obstructed or a fan fails. It is recommended that you regularly verify that the exhaust is functioning correctly.

⚠ CAUTION Never disable the vane switch. Attempting to operate the projector with inadequate airflow can result in dangerous overheating of the projector.

2.9 Remove the Shroud

To access the MLM and lens, you need to remove one shroud. Remove the second shroud when you use a Motorized Auxiliary Lens Mount or a Real D Z.

1. Using finger pressure, push down on the locations specified by the red arrows in the diagram.
2. Carefully slide the shroud sideways and forward away from the MLM and lens.
3. Place the shroud cover on a clean surface to prevent scratches.

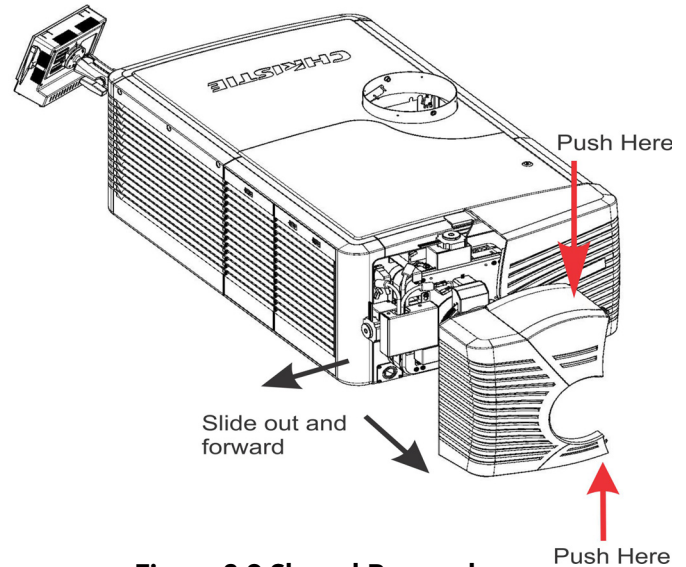


Figure 2-9 Shroud Removal

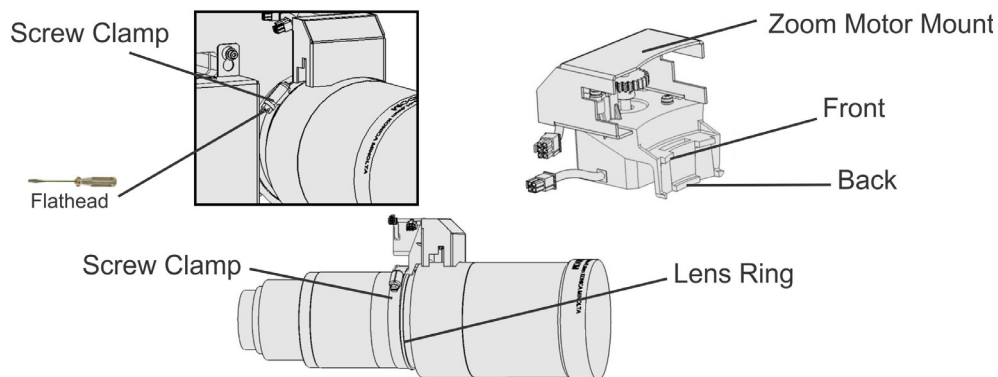
2.10 Install the Primary Lens

The lens seals the projection head, preventing contaminants from entering the main electronics area. Do not operate the projector without a lens installed. Install a lens plug when you install or transport the projector.

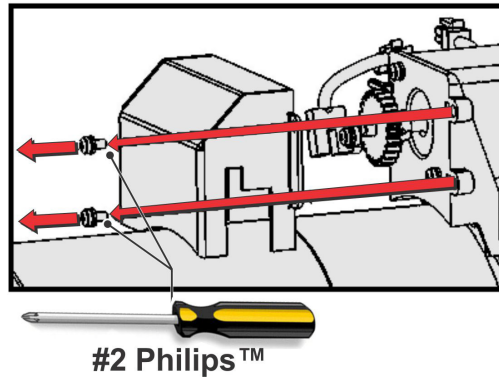
⚠ WARNING To prevent a collision between the projection lens and the Motorized Auxiliary Lens Mount (MALM), move it to the OUT position before you calibrate the lens or perform reset functions. Keep your fingers and other body parts away from the moving parts in the projector. Motors and fans may start without warning. Tie back long hair, remove jewelry and loose clothing before manually adjusting the projector.

NOTE: 1) Make sure the zoom ring is against the front of motor mount for lenses: 1.6-2.4:1, 1.8-3.0:1, 2.15-3.6:1. **2)** Make sure the zoom ring is against the back of motor mount for lenses: 1.45-2.05:1, 1.25-1.83:1. **3)** All other lenses: Leave a gap between the rotating zoom section of lens and motor mount.

1. Unpack the zoom motor kit.
2. Use a flathead screwdriver to install the zoom motor mount onto the lens with a screw clamp.

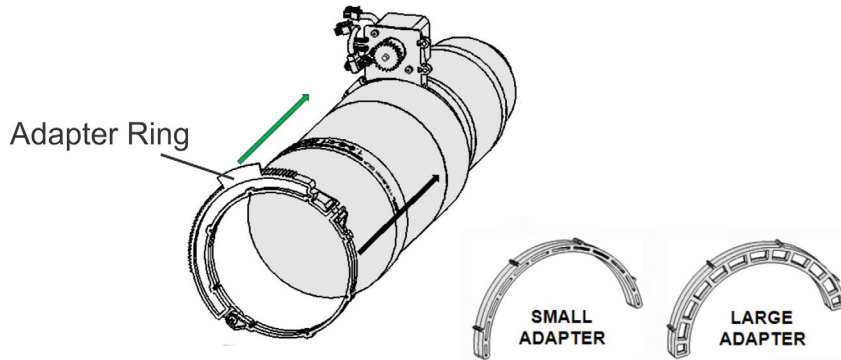


- Remove the cover from the zoom motor mount with a Phillips screwdriver. Keep the hardware and cover.



- Install zoom gear ring and adapter onto the lens.

NOTE: 1) Use a small adapter for lens 1.8-3.0. **2)** Use a large adapter for lens 1.45-2.05, 2.15-3.6, 1.25-1.83:1 **3)** All other lenses do not need an adapter.



- Verify that there is full travel of the gear ring, and the alignment of the sensor is correct.

NOTE: There must be a small gap between the gears to prevent binding. To ensure there is a gap, loosen the screws and readjust the gap. Tighten the screws when you have completed the adjustment.

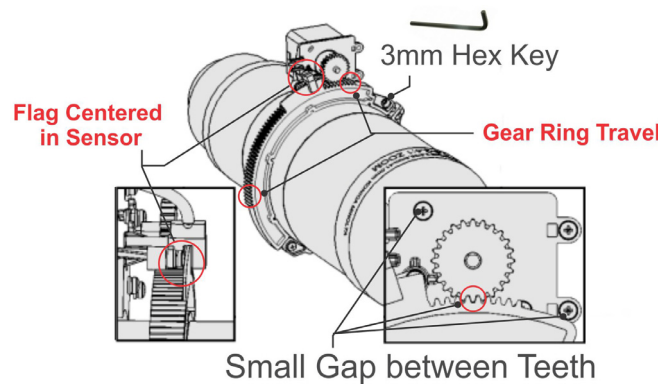
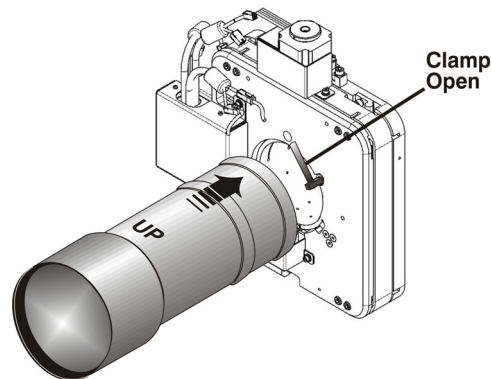


Figure 2-10

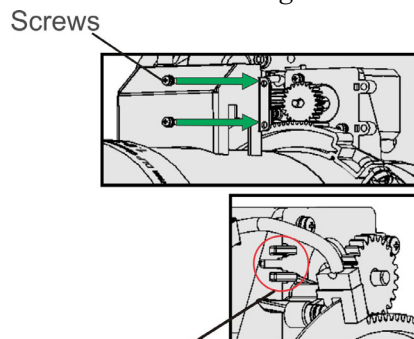
6. Turn the lens clamp to the OPEN position on the MLM and fully insert the assembly straight into the lens mount opening without turning. When the lens is fully inserted it is seated properly within the lens mount and the aperture is installed correctly.



Note: Zoom motor/adaptor removed for clarity

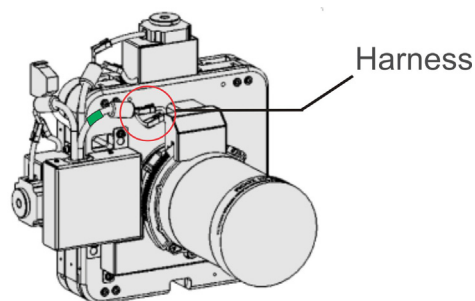
7. Install the cover with the screws.

NOTE: Make sure the cover is between the mounting tabs.

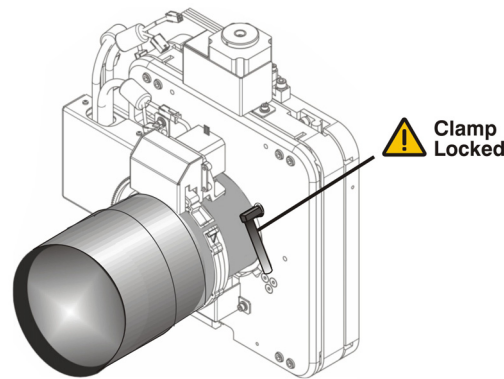


Mounting tabs

8. Connect the harness wires.



9. Position the lens clamp DOWN to lock the lens assembly in place.



10. Calibrate the lens. See [Section 4.3 Basic Image Alignment](#) for details.
11. Install the shroud.

2.11 Install the Optional Anamorphic Lens

1. Make sure to optimize your primary lens first for best optical alignment, offset and boresight.
2. Install the auxiliary lens mount using the instructions included with the kit.
3. Loosen the holding clamp on the auxiliary lens mount. Adjust the rotation of the anamorphic lens so the image remains perfectly square with anamorphic in and out.
4. Adjust the location of the anamorphic lens so that the image does not shift left or right with the anamorphic lens in and out.
5. Adjust the location of the anamorphic lens so the image passes through the center as much as possible without vignetting, reducing side or corner brightness, especially in wide angle projection.
6. Remove the anamorphic lens and turn the Focus knob to re-focus the primary lens. The goal is for good focus at the center and on all sides.
7. Re-install the anamorphic lens and check the focus.
8. If center-to-edge horizontal focus in the image needs improvement, rotate the focus barrel.

2.12 Install the Optional Wide Converter Lens

1. Optimize the primary projector lens for optical alignment, offset, and boresight.
2. Install the Auxiliary Lens Mount and Wide Converter Lens (WCL) using the instructions included with the kit.
3. Adjust the vertical and horizontal position of the WCL to align it with the primary lens.
4. Adjust the pitch, up or down to equalize the top and bottom clearance to the primary lens barrel.
5. Adjust yaw to make the clearance between both lens barrels equal from side-to-side.

2.13 Install the Lamp

⚠ DANGER This procedure should only be performed by a Christie accredited technician. High-pressure lamp may explode if improperly handled. Always wear approved protective safety clothing whenever lamp door is open or when handling the lamp.

1. If the projector is operating, turn it off and allow it to cool a minimum of 10 minutes.
2. Turn the breaker switch for the projector off.
3. Disconnect the projector from AC power.
4. Put on your protective clothing and face shield.
5. Use the security key to open the lamp door and access the lamp cooling compartment. Do not place heavy objects on the open lamp door.
6. Install the anode yoke assembly. Use this table to determine the correct position of the anode yoke assembly.

Table 2.2 Lamp Types Available for CP4220 and Anode Yoke Position

LAMP	TYPE	ANODE YOKE POSITION
2.0 kW	CDXL-20	Move the lamp cradle as far forward as possible (position closest to igniter)
3.0 kW	CDXL-30	Move the lamp cradle to the rear position, which is approximately 1" closer to the reflector.)
	CDXL-30SD (short arc)	
	CXL-30	

7. Install the lamp. See [Section 7.9 Replace the Lamp](#) for lamp replacement instructions. Observe all warnings, and wear protective safety gear.

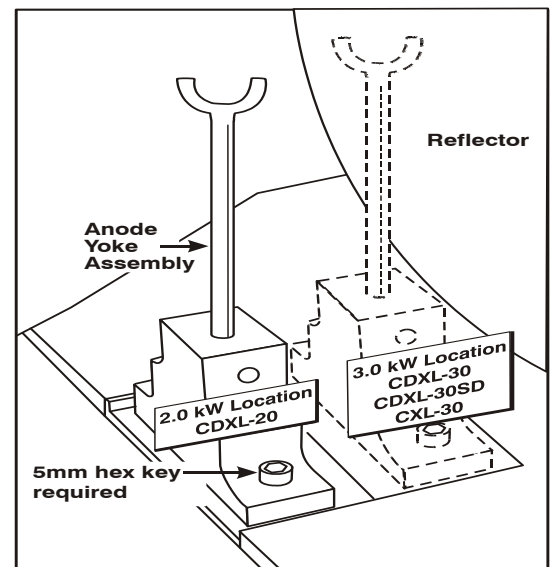


Figure 2-11 Yoke assembly installa-

2.14 Connect the Projector to AC Power with a Permanent Connection

⚠ WARNING 1) Certified electrician required. 2) Ground (earth) connection is necessary for safety. Never compromise safety by returning the current through the ground. 3) Connect ground **FIRST** to reduce shock hazard from high leakage.

⚠ CAUTION Use an appropriate strain relief connector on the AC supply cable to prevent the cable from rubbing against the projector knockout plate and becoming damaged.

When connecting the projector to AC power, follow all electrical codes for your location. In addition, follow these recommendations:

- A 30-32A double pole, UL listed wall circuit breaker is required. It must be part of the building installation and easily accessible.
 - Use 10AWG or 8AWG wiring. The distance between the wall circuit breaker and the projector must not exceed 20 meters using 10AWG cables or 30 meters using 8AWG cables.
 - For North American installations, use at least 10AWG copper wires for the connection of the main AC supply to the projector's ground lug.
 - Copper or aluminum are acceptable as conductor wiring material to the terminal block.
1. On the bottom of the projector in the front right corner, loosen the two screws and slide the plate forward to expose the terminal block.

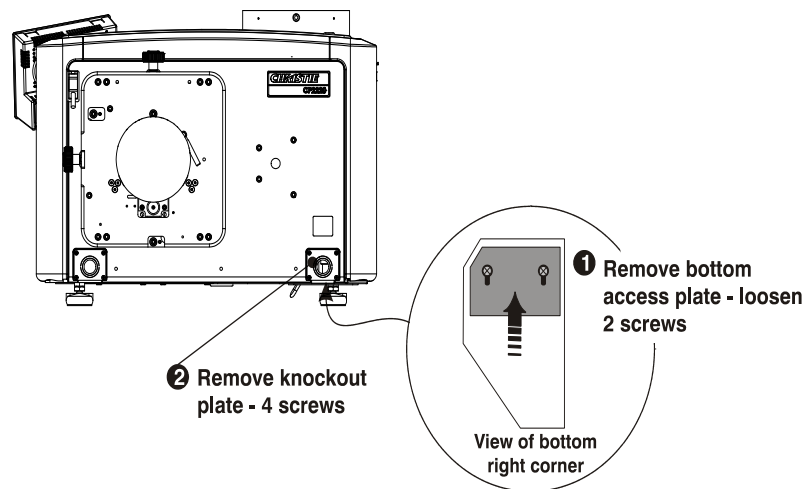


Figure 2-12

2. Remove the knockout plate located in the bottom right corner of the front bezel. The AC supply is routed to the terminal block through an appropriate strain relief mounted on this knockout plate.
3. Connect the AC power source to the terminal block, beginning with the ground lead first. Use an appropriately sized strain relief connector with the knockout plate provided to ensure adequate environmental sealing and to prevent the cables from wear and accidentally being torn out. **NOTES: 1)** *The terminal block accommodates up to an 8 AWG wire.* **2)** *If desired, a 90° strain relief connector can be used to route the power cable in a downward direction.*

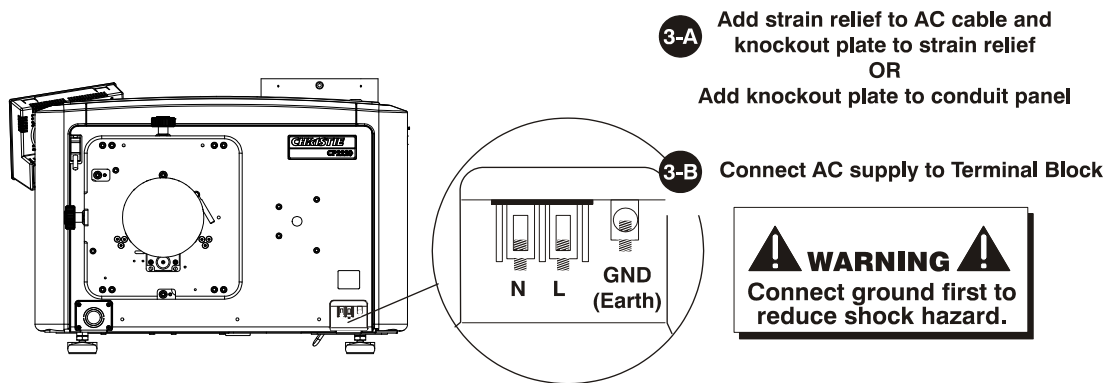


Figure 2-13

4. Replace the knockout plate and the bottom access panel over the terminal block.

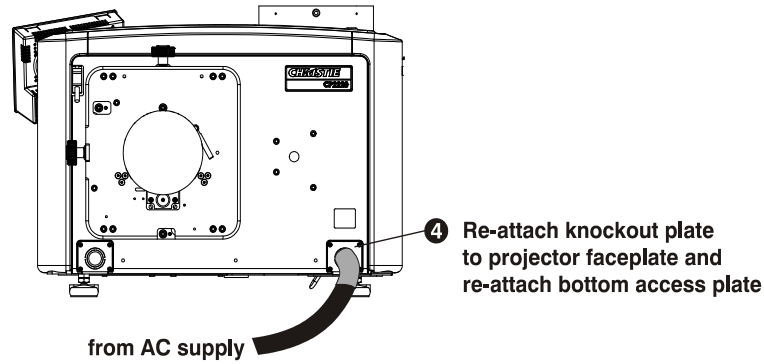
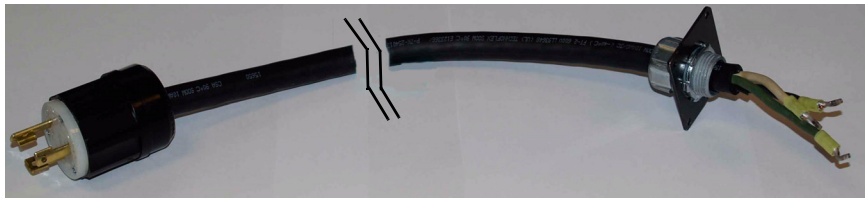


Figure 2-14

2.15 Connect the Projector to AC Power with a Pluggable Type B Connection

When connecting the projector to AC power, follow all electrical codes for your location. In addition, follow these recommendations:

- There must be easy access to the current protection device or breaker in the building.
- Use 10AWG or 8AWG wiring: the distance between the wall circuit breaker and the projector must not exceed 20 meters using 10AWG cables or 30 meters using 8AWG cables.
- The socket-outlet is installed near the equipment and is easily accessible.
- The plug can be used as the device disconnect and is near the unit and easily accessible.



**Figure 2-15 Nema-L630A 250V Male Power Plug (116-102104-01)
Actual Length 1.5 Meters**

1. On the bottom of the projector in the front right corner, loosen the two screws and slide the plate forward to expose the terminal block.
2. Remove the knockout plate (four screws) located in the bottom right corner of the front bezel.
3. Connect the AC power source to the terminal block, beginning with the ground lead first. Tighten screws securely.
4. Secure the knockout plate (four screws) and the bottom access panel (two screws) over the terminal block.

2.16 Configure the Optional Uninterrupted Power Supply

A UPS allows the projector head electronics to remain operable during a power failure.

Unplug the LVPS input connection from Main Power and connect it to the UPS input plug. Re-use the dummy plug from the UPS connection with the unused Main Power plug.

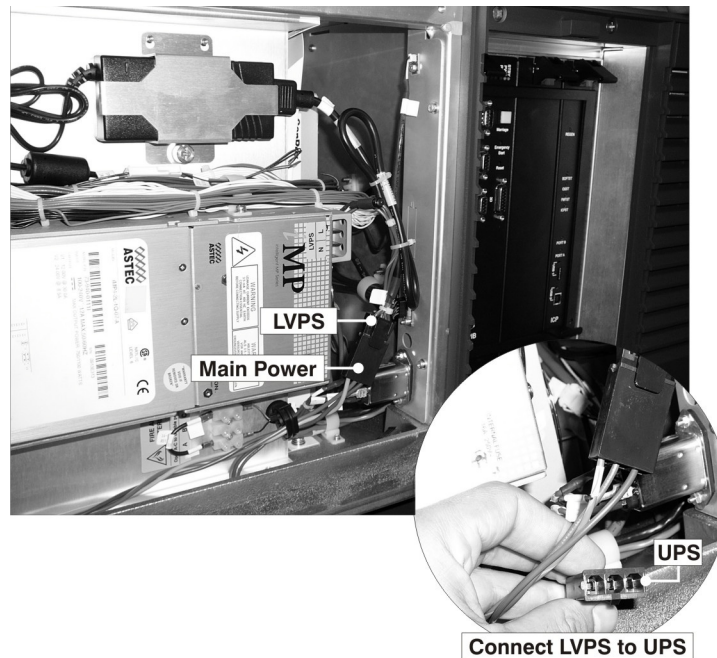


Figure 2-16

2.17 Connect Sources and Turn the Projector On

1. Assign the projector a unique IP address and enter a baud rate:
 - Tap **Menu** > **Administrator Setup** > **Communications Configuration**.
 - Enter the IP address for the projector in the **IP Address** field.
 - Select a baud rate for the input device in the **Serial Speed (Baud)** list.
2. Enter lamp information:
 - Tap **Menu** > **Advanced Setup** > **Lamp History**.
 - Tap **Add Lamp**.
 - Complete the fields in the **Add Lamp** dialog.
 - Tap **Save**.
3. Tap and hold the green power button to turn the projector on.
4. Complete a LampLOC™ alignment on the new lamp:
 - Tap **Menu** > **Advanced Setup** > **LampLOC™ Setup**.
 - Tap **Do Auto**.

Section 2: Installation and Setup

5. Complete an optical alignment to optimize images displayed on screen. See [Section 4.3 Basic Image Alignment](#).
6. Adjust optical components if required.

3 Connect Devices to the Projector

This section provides information and procedures for connecting input devices to the projector. You connect input devices to the Projector Intelligence Board (PIB) located on side of the projector.

These communication ports are accessible by removing the side source and communication access panel. When connecting devices, route all cables along the channels located on the bottom of the projector and up through the opening in the frame to the communication connection port.

Replace the access panel to ensure server and source connections remain secure.

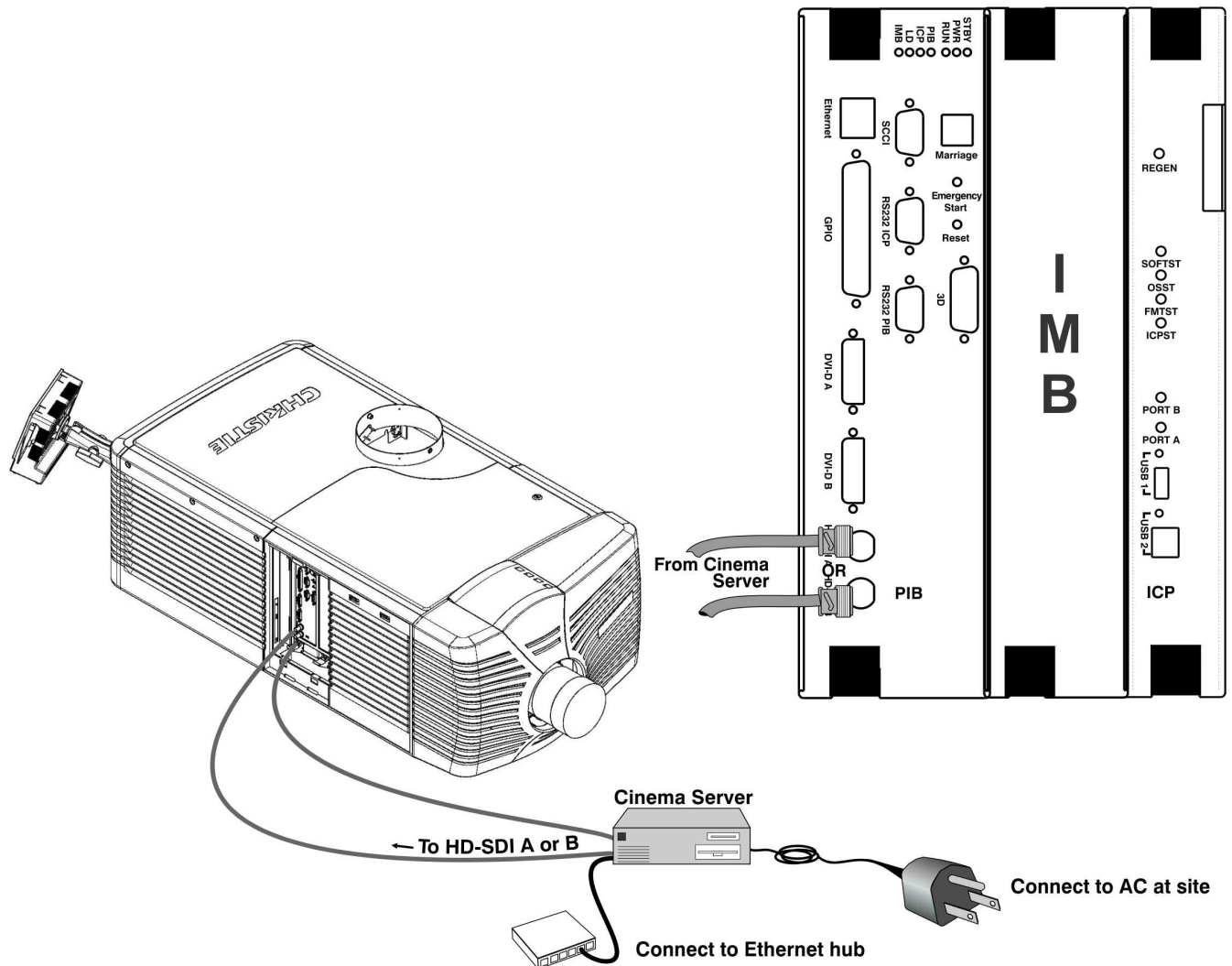


Figure 3-1 Connecting Cinema Sources

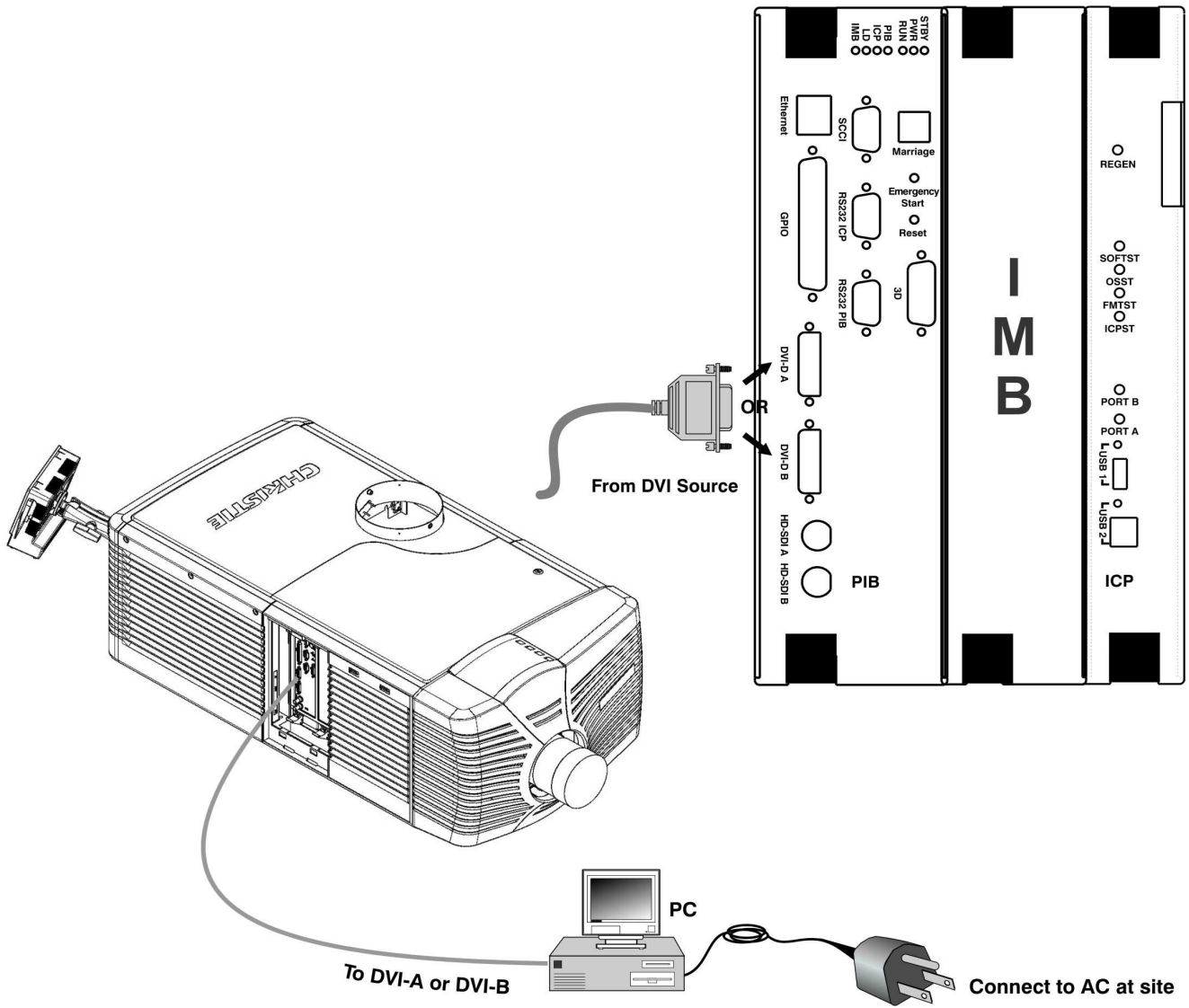


Figure 3-2 Connecting Non-Cinema Sources

3.1 Connect a Computer or Server

To communicate with the projector from a computer, server or an existing network, connect the equipment to the Ethernet hub or switch.

For applications or equipment utilizing serial communications, use the Christie-proprietary serial protocol to connect to the RS232 PIB port on the PIB. When using Christie serial protocol over Ethernet, connect to port 5000. **NOTICE:** *The RS232 PIB port located on the PIB faceplate utilizes Christie-proprietary protocol and is intended for Christie accessories or automation controllers only.*

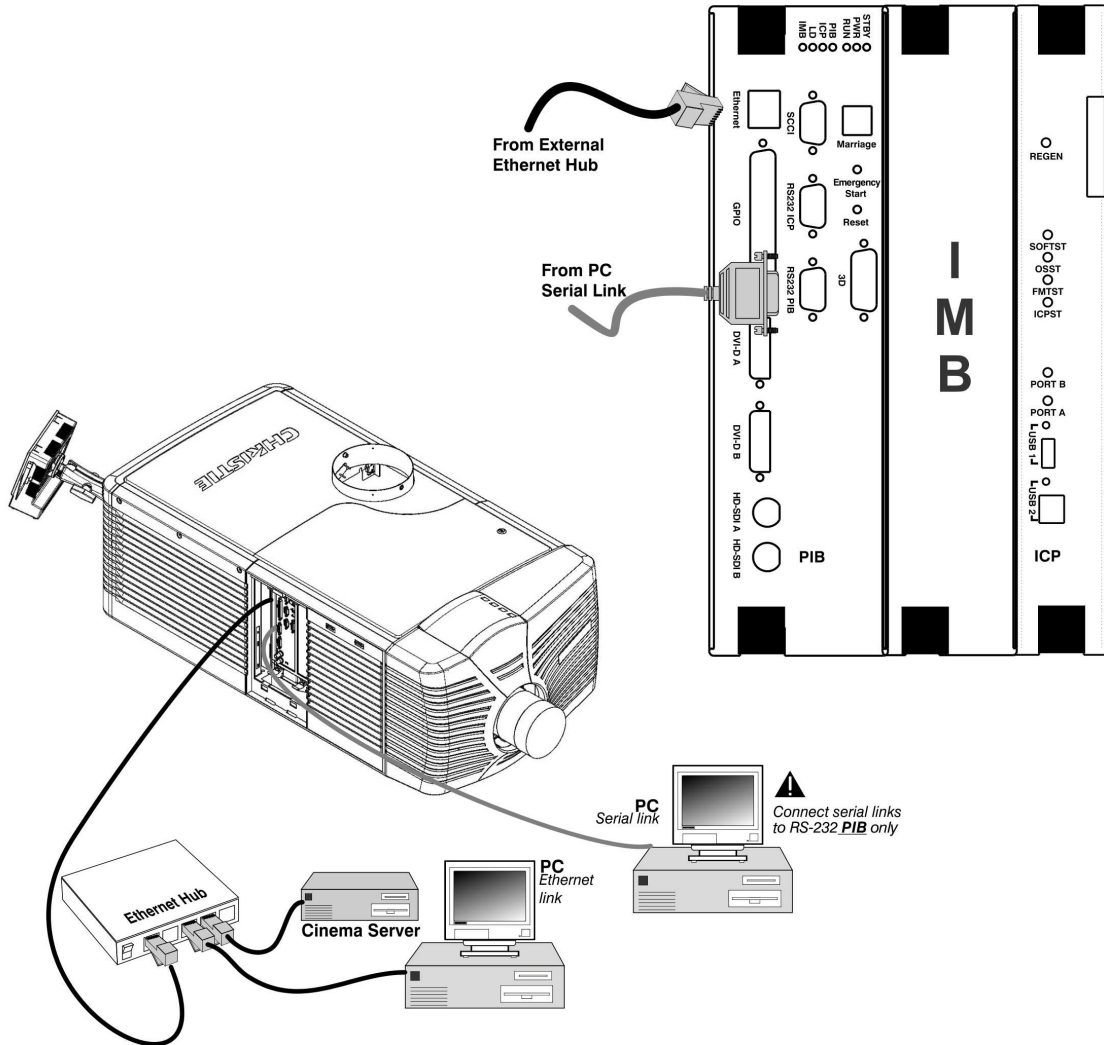


Figure 3-3 Connecting Communications

3.2 Connecting Devices to the SCCI Port

The Simple Contact Closure Port (SCCI) port is a DB-9 (male) connector is located on the PIB input panel and is used to control a limited set of projector functionality through contact closures. This table lists the control functions available through the SCCI:

Table 3.1 SCCI Connector Pinouts

PIN	SIGNAL NAME	DIRECTION	DESCRIPTION
1	+5V Standby	Out	Current limited 5VDC supply
2	Lamp ON	In	Projector at Power On mode, lamp is ON
3	+5V Standby	Out	Current limited 5VDC supply
4	Lamp OFF	In	Projector at full power, lamp is OFF
5	+5V Standby	Out	Current limited 5VDC supply
6	Douser Closed	In	Close douser
7	Douser Open	In	Douser open
8	Health Output	Out	<p>Open Collector Low when one of the following interlocks is tripped or conditions present:</p> <ul style="list-style-type: none"> • Lamp Door • Lamp Blower • Extractor • Tamper • Marriage • Ballast Communication <p>The show will not be able to play. Open Collector High when all interlocks relevant to CineLink and Lamp are not tripped. The show is able to play.</p>
9	Ground	Out	Ground

NOTE: All SCCI inputs require a pulse input of 50ms to several seconds to operate reliably. Inputs are 5V resistor current limited LED's inside of optocouplers.

A “Health Output” on this connector is also provided for locations that require a projector Health Output. The output is an open-collector circuit which only draws power when the projector is deemed to be “un-healthy”. The primary use of the Projector Health Output is to ensure that patrons are not left in a dark theatre due to projector fault. Therefore, any fault that results in the movie playback stopping should cause this circuit to draw power and indicate an un-healthy state. The projector is always considered to be “healthy” in Standby Mode since there is no fear of projector fault causing an impact to patrons, and there should be no patrons in the theatre at that time.

3.3 Connecting Devices to the GPIO Port

The GPIO port is a 37-pin D-sub connector (female) located on the PIB input panel and provides 8 input and 7 output signals for connecting external devices to the projector. To configure the pins on the connector, tap **Menu > Administrator Setup > GPIO Setup**.

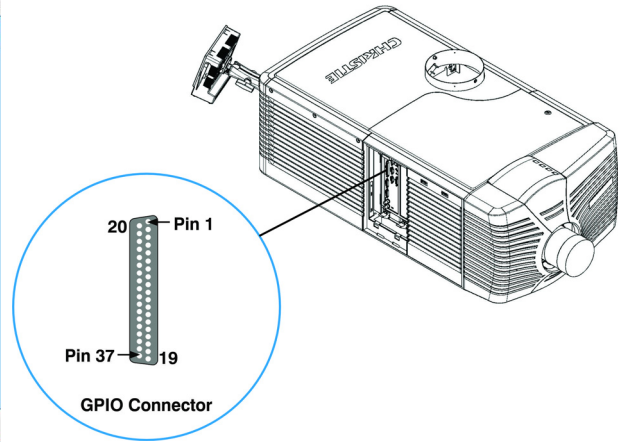
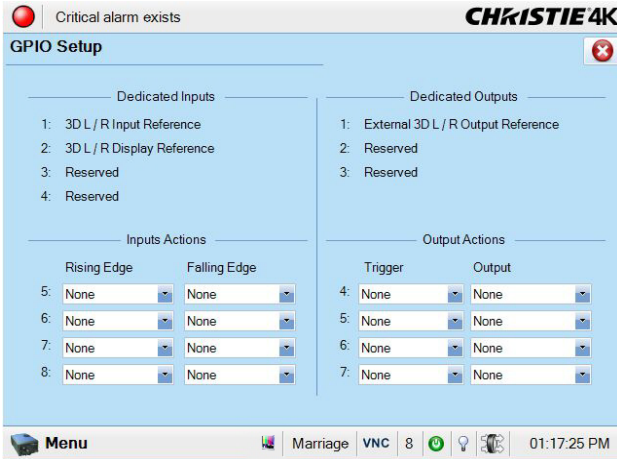


Figure 3-4 Admin: GPIO Setup Window and GPIO Port Location on Projector

As shown below, each available pairing of pins (+/–) is defined as either an *input* or *output*. Four inputs and three outputs have already been predefined. Configure a pin as an input if you want the projector to respond to an incoming signal, or as an output if you want an external device to respond to the projector.

Inputs	Positive	Negative	Description
GPIN #1	Pin 1	Pin 20	3-D L/R Input Reference
GPIN #2	Pin 2	Pin 21	3-D L/R Display Reference
GPIN #3	Pin 3	Pin 22	Reserved
GPIN #4	Pin 4	Pin 23	Reserved
GPIN #5	Pin 5	Pin 24	Input
GPIN #6	Pin 6	Pin 25	Input
GPIN #7	Pin 7	Pin 26	Input
GPIN #8	Pin 8	Pin 27	Input

Outputs	Positive	Negative	Description
GPOUT #1	Pin 9	Pin 28	External 3-D L/R Output Reference
GPOUT #2	Pin 10	Pin 29	Reserved
GPOUT #3	Pin 11	Pin 30	Reserved
GPOUT #4	Pin 12	Pin 31	Output
GPOUT #5	Pin 13	Pin 32	Output
GPOUT #6	Pin 14	Pin 33	Output
GPOUT #7	Pin 15	Pin 34	Output
PROJ_GOOD	Pin 16	Pin 35	Projector Good

If you are wiring your own GPIO cable for use with a server or 3D device such as an IR emitter or a polarizer, follow the circuit diagram.

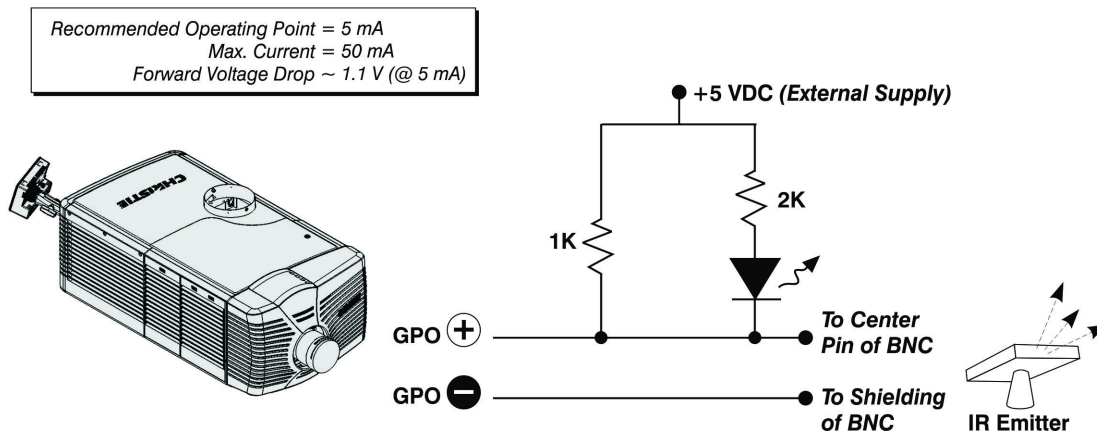


Figure 3-5 GPIO Circuit Diagram

3.4 Connecting Devices to the 3D Connector

The 3D connector is a 15-pin D-sub connector (female) located on the PIB input panel. This table lists the control functions available through the 3D connector.

PIN	SIGNAL NAME	DIRECTION	DESCRIPTION
1	+12V	Out	Power to 3D device. Maximum 1A (total between both +12V pins).
2	GND	/	Ground
3	GND	/	Ground
4	RS232_RX	In	Data to projector from 3D device. 1200 Baud, 8 bits, no parity. Currently unsupported.
5	RS232_TX	Out	Data to projector from 3D device. 1200 Baud, 8 bits, no parity. Currently unsupported.
6	CONN_3D_MODE+	Out	SYNC from projector. To projector GPO collector. Compatible with current projector GPIO requirements and restrictions. (24VDC max, 50mA max) 3D ON = Hi logic level = O/P transistor ON 3D OFF = Low logic level = O/P transistor OFF
7	CONN_SYNC+	Out	SYNC from projector. To projector GPO collector. Compatible with current projector GPIO requirements and restrictions. (24VDC max, 50mA max)
8	3D_INPUT_REFERENCE+	In	3D L/R Input Reference (P) (Voltage Limit: 1.4VDC to 12VDC)
9	+12V	Out	Power to 3D system. Maximum 1A (Total between both +12V pins)
10	3D_INPUT_REFERENCE-	In	3D L/R Input Reference (N) (Voltage limit: 1.4VDC to 12VDC)
11	3D_DISPLAY_REFERENCE+	In	3D L/R Input Reference (P) (Voltage limit: 1.4VDC to 12VDC)
12	3D_DISPLAY_REFERENCE-	In	3D L/R Input Reference (P) (Voltage limit: 1.4VDC to 12VDC)
13	CONN_3D_MODE-	Out	3D mode state from projector. From projector GPO emitter. Compatible with current projector GPIO requirements and restrictions. (24VDC max, 50mA max)
14	CONN_SYNC-	Out	SYNC from projector. From projector GPO emitter. Compatible with current projector GPIO requirements and restrictions. (24DC max, 50mA max)
15	Not connected		

4 Adjust the Image

This section provides information and procedures for adjusting the projector image.

4.1 Maximize Light Output

To ensure optimal operation and peak screen brightness, use LampLOC™ to adjust the lamp position whenever you install a new lamp. When you complete the LampLOC adjustment, the lamp is centered and is the correct distance from the illumination system. Before running LampLOC, verify that:

- The anode yoke is in the correct position for the lamp type.
 - The lamp extension nut is installed when using a CDXL-30SD lamp. Remove the nut if you are not using a CDXL-30SD lamp.
 - The lamp is on and the douser is open.
1. On the Touch Pad Controller, tap the **Test Patterns** icon.
 2. Tap the **Full Screen White** test pattern.
 3. Tap **Menu > Advanced Setup > LampLOC™ Setup**.
 4. Tap **Do Auto**.

4.2 Calibrate Screen Brightness (fL)

1. On the Touch Pad Controller, tap **Menu > Administrator Setup > Foot Lamberts Calibration**.
2. Complete the **Foot Lamberts Calibration** wizard.

4.3 Basic Image Alignment

This procedure ensures that the image reflected from the digital micromirror device (DMD) is parallel and centered with the lens and screen. This procedure must be completed before you complete a boresight adjustment.

1. Verify the projector is properly positioned relative to the screen. See [Section 2.5: Position the Projector](#).
2. Display a test pattern that you can use to analyze image focus and geometry. The framing test pattern works well for this.
3. Perform a preliminary focus and (if available) a zoom adjustment with the primary lens. Focus the center of the image first. See [Section 5.7: Present Movies](#).
4. Hold a piece of paper at the lens surface and adjust the offsets until the image is centered within the lens perimeter.
5. With the framing test pattern on screen, re-check projector leveling so the top edge of the image is parallel to the top edge of the screen.

4.4 Adjust Offset

Project an image with the primary lens. Always adjust offset before boresight.

Select a framing test pattern and then adjust the horizontal and vertical offset to display a square image on the screen with minimal projector aiming error.

NOTES: 1) *For the best optical performance and minimize keystone error, use offset and not aiming to center the image in off axis installations. 2)* *Avoid extreme tilts or offsets. Corner vignettes on a white test pattern indicate extreme offset that should be avoided using mechanical alignment.*

4.5 Adjust Offset with an ILS

Project an image with the primary lens. Always adjust offset before boresight. Ensure the correct lens is selected in the Advanced Setup: Lens Adjust window before calibration to ensure you remain within the applicable boundary of the installed lens.

1. Tap **Menu > Advanced Setup > Lens Setup**.
2. Tap **Enable Automatic ILS**. Enabling Automatic ILS overwrites the pre-defined settings for the channel.
3. Tap the Test Patterns icon and select a framing test pattern.
4. Tap **Menu > Advanced Setup > ILS File Setup**.
5. Tap the directional arrows in the **Offset** area. For best optical performance, make sure to minimize keystone error by using offset more than aiming to center the image in off axis installations. Avoid extreme tilts or offsets. Corner vignettes on a white test pattern indicates extreme offset that should be avoided using mechanical alignment.

4.6 Adjust Left and Right Boresight

When performing these adjustments the goal is to balance the tilt of the lens mount to compensate for screen to projector tilt, but also to precisely maintain the original factory settings of the lens mount axial position.

1. Loosen the horizontal locking screw.

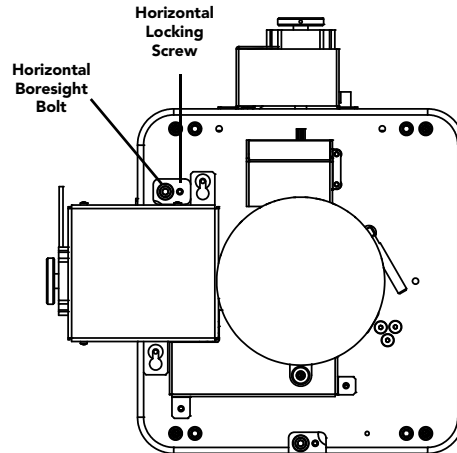


Figure 4-1 Horizontal Boresight

2. Extend the lens focus completely.
3. Adjust the **Focus** using the focus knob to retract the lens. Watch the image at the left edge of the screen until it comes into focus. If the entire screen is in focus, proceed to step 7.

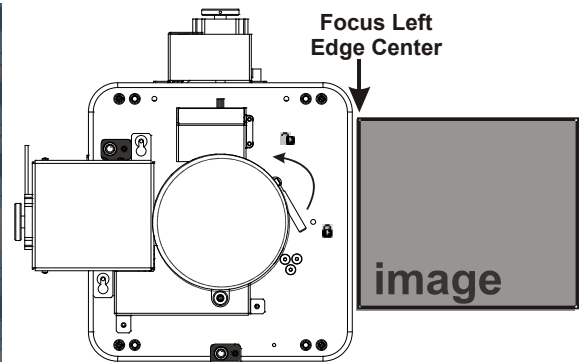
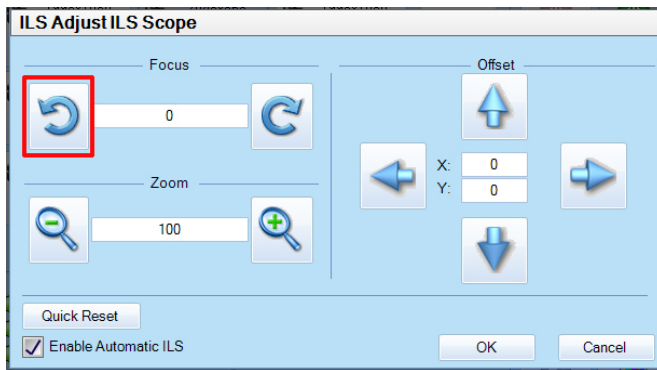


Figure 4-2 Adjust Focus

4. Continue retracting the lens.
 - a. If the right side of the image comes into focus before the lens is completely retracted, adjust the horizontal boresight bolt to balance the left and right edges.
 - b. If the right side of the image fails to come into focus, adjust the horizontal boresight bolt.
5. When both sides appear equally blurry, adjust the horizontal or vertical offset to re-center the image.
6. Repeat steps 1 - 5 until both sides of the image are focused.
7. Tighten the horizontal hold screw to maintain your adjustments.
8. Check the boresight again.

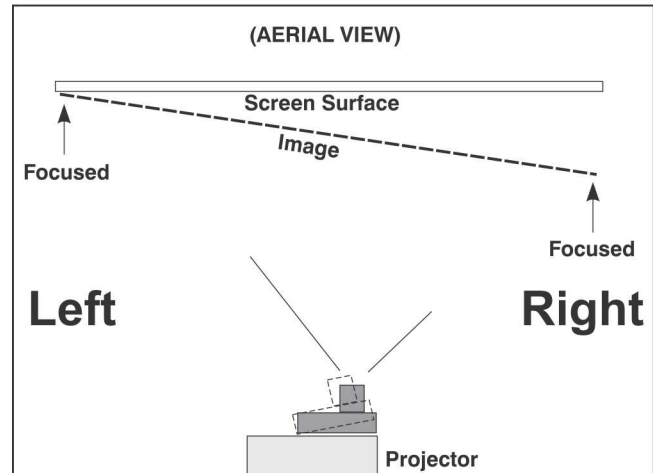


Figure 4-3 Aerial View Illustrating Misaligned Boresight

4.7 Adjust Top and Bottom Boresight

1. Focus the image at the top edge of the screen.
2. Loosen the vertical hold screw.
3. Extend the lens focus completely.
4. Adjust the **Focus** knob to retract the lens. Watch the image at the top edge of the screen until it comes into focus. If the entire screen is in focus, proceed to step 8.
5. Continue retracting the lens.
 - a. If the bottom edge of the image comes into focus before the lens is completely retracted, adjust the vertical boresight bolt to direct or aim the lens mount UP towards the top of the screen to balance out the top/bottom edges.
 - b. If the top edge of the image is not in focus, adjust the vertical boresight bolt to direct or aim the lens mount toward the bottom of the screen.
6. When both sides appear equally blurry, adjust the horizontal and/or vertical offset to re-center the image on the screen.
7. Repeat Steps 2 - 5 until the top and bottom of the screen are both well-focused.
8. Re-focus the center of the image. The goal is for good focus at the center and on all sides.

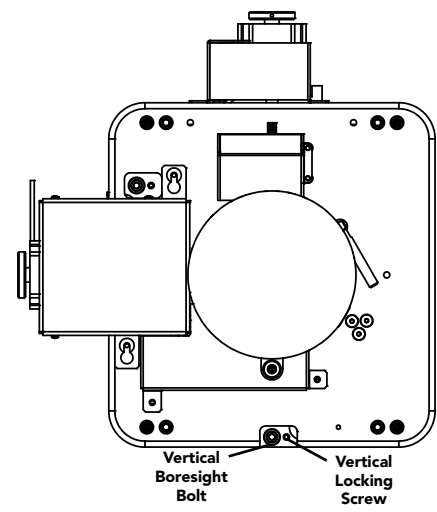


Figure 4-4 Vertical Boresight

9. Tighten the vertical hold screw to maintain your adjustments.

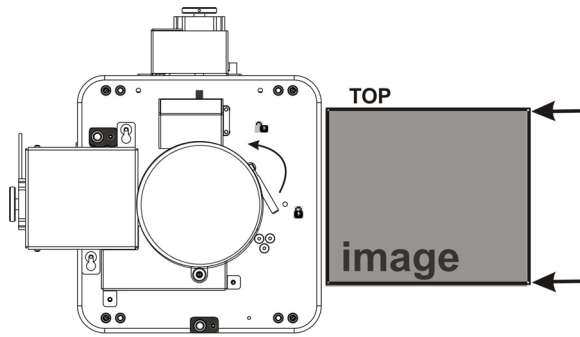


Figure 4-5 Adjust Vertical Boresight

10. Check the boresight again.

4.8 Adjust Top and Bottom Boresight with an ILS

1. Loosen the **Vertical Locking Screw**.
2. Extend the lens focus completely.
3. Adjust the Focus to retract the lens using the counter-clockwise button on the ILS Adjust window. Watch the image at the top edge of the screen until it comes into focus. If the image appears well-focused on the top edge but not on the bottom, we need to determine if the bottom edge focuses in front of or behind the screen. If the entire screen comes into focus, skip to step 8.
4. Continue retracting the lens.
 - a. If the bottom edge of the image comes into focus before the lens is completely retracted, then the image focuses in front of the screen. To correct this problem, adjust the **Vertical Bore-sight Bolt** to direct or aim the lens mount UP towards the top of the screen to balance out the top/bottom edges.
 - b. If the top edge of the image fails to come into focus then the image focuses behind the screen. To correct this problem, adjust the **Vertical Boresight Bolt** to direct or aim the lens mount DOWN towards the bottom of the screen.
5. When both sides appear equally blurry, tap **Menu > Advanced Setup > ILS File Setup** and tap the directional arrows in the **Offset** area to center the image on the screen.
6. Repeat Steps 2 - 5 until the top and bottom of the screen are both well-focused.
7. Although all sides of the image should now be in focus, the center of the image may be slightly blurry at this point. Re-focus the center of the image. The goal is for good focus at the center and on all sides.
8. Adjust the **Vertical Locking Screw** to lock the lens mount in place and check boresight again.

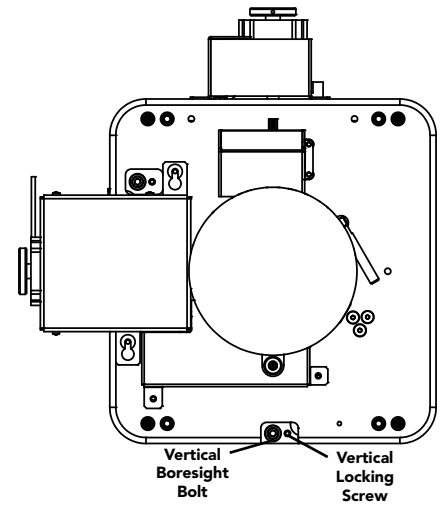


Figure 4-6 Vertical Boresight

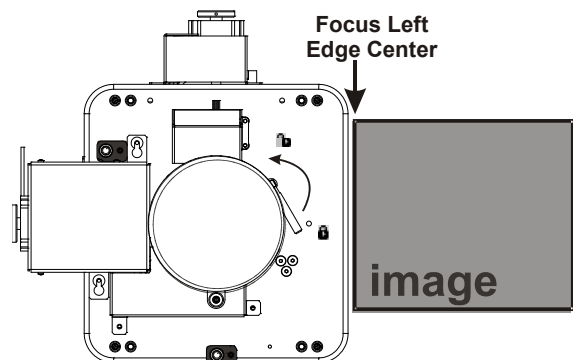


Figure 4-7 Adjust Vertical Boresight

4.9 Adjust DMD Convergence

⚠ DANGER UV EXPOSURE! Protective UV glasses must be worn when performing convergence adjustments.

A convergence problem occurs when one or more projected colors (red, green, blue) appears misaligned when examined with a convergence test pattern. Normally, the three colors should overlap precisely to form pure white lines throughout the image and one or more poorly converged individual colors may appear adjacent to some or all of the lines. Contact your Christie accredited service technician to correct DMD convergence issues.

4.10 Fold Mirror Adjustment

If a corner or edge of an image is missing, the fold mirror might be misaligned with the optical system. To correct this issue:

- Adjust the screw closest to the operator's side (right side, when facing screen) to raise or lower the image.
- Adjust the screw on the left side to move the image left or right.

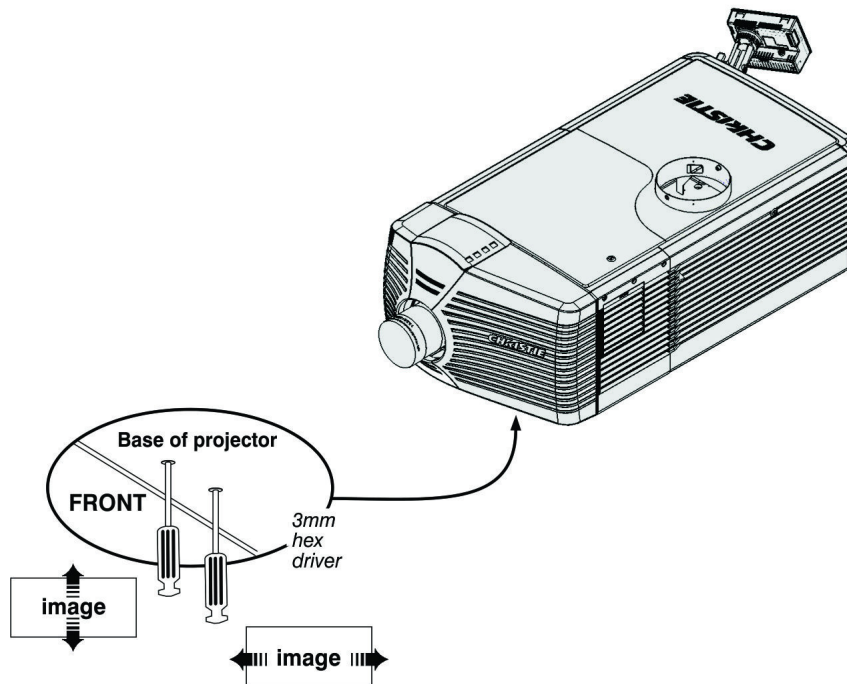


Figure 4-8 Fold Mirror Adjustment

4.11 Calibrating the System

Use the TPC interface for calibrating the image color performance and defining electronic screen masking. This is required in your particular installation for the creation of Source, Screen, MCGD and TCGD files necessary for proper display of incoming material. You can also define the system/network configuration for communication links to the projector and transmit information to and from the CP4220 via an Ethernet or RS-232 connection.

4.12 Color Calibration

To ensure an accurate color display:

1. Measure the colors displayed on the screen from the center of the audience viewing location to determine the Measured Color Gamut Data (MCGD) value.
2. On the Touch Pad Controller tap **Menu > Advanced Setup > MCGD File Setup** and enter the color values in the x and y fields for the different colors.
3. Tap **Save**. The software automatically determines the Target Color Gamut Data (TCGD) value. The TCGD value determines what corrections are needed to display the correct colors.

4.13 Electronic Screen Masking

You can use the masking tool to correct image edge blanking. The masking tool produces results that are similar to filing the aperture plate in a film projector. After you create the Flat and Scope screen files you can use them in multiple channels.

4.14 Working with 3D

This section provides information and procedures for setting up and managing 3D presentations.

4.14.1 Display Requirements

To display 3D images with the CP2220 projector, you require these items:

- A 3D hardware system:
 - Pi-Cell polarizer for display on a screen that has a silver polarization-preserving surface for use with passive glasses (RealD).
 - Rotating polarizing wheel (external) with passive circular polarizing glasses (MasterImage). Requires a silver screen.
 - IR emitter for controlling the left eye/right eye gating (switching) of active glasses (Xpand).
 - Dual projector 3D - passive glasses (circular or linear). Requires a silver screen.
- A 3D connection cable:
 - 3D sync output cable (GPIO).
 - 3D connector.
- Power supply for your sync output device.

4.14.2 Hardware Setup

Use an infrared emitter to control gating in active glasses, a polarizing Z-screen (Pi-cell) with passive glasses or filter wheel with passive glasses.

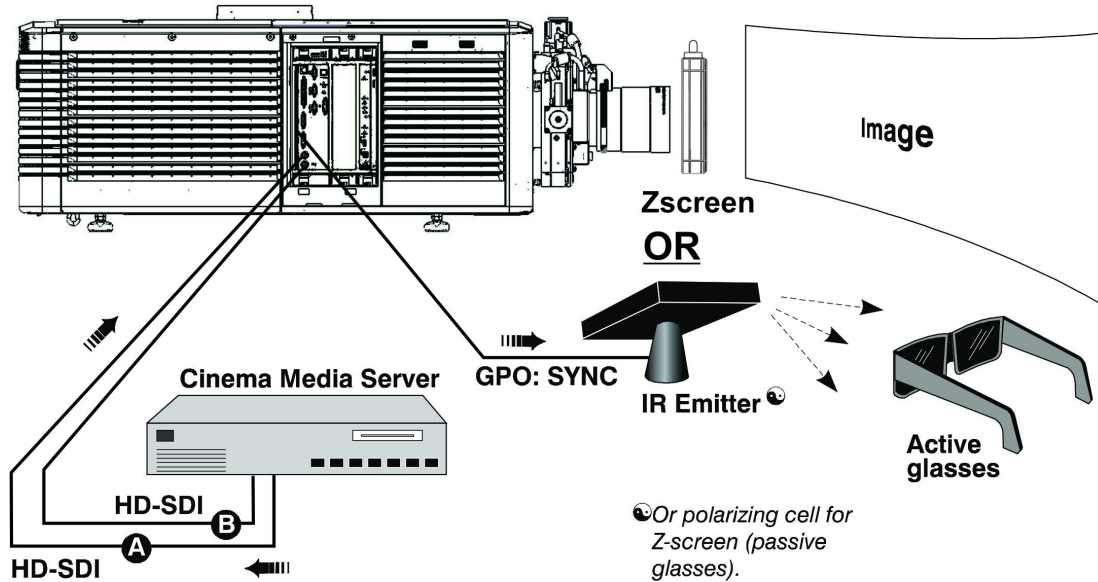


Figure 4-9 3D Hardware Setup

Table 4.1 3D Hardware Systems

	RealD Z-screen	RealD XL Box	Dolby Filter Wheel	Xpand	Master Image	Dual Projector
Installed/ Mounted Components	Z-screen mounted in front of the projection lens	XL box mounted in front of the projection lens	Installed filter wheel inside the projector	None	Installed wheel in front of the projector	Polarizing plates in front of lenses
Silver Screen	Yes	Yes	No	No	Yes	Yes
3D Glasses	Polarizing circular glasses	Polarizing circular glasses	Color filter glasses	Active glasses	Circular polarized glasses	Polarizing circular or linear glasses

4.14.3 Install a 3D Server with an YCxCz Interface

1. Install and connect your 3D hardware to the projector.
2. Edit and apply the default 3D lamp file:
 - a. Tap **Menu > Advanced Setup > Lamp Power/LiteLOC Setup**.
 - b. Set the brightness percentage for the lamp in the **Power%** field.
 - c. Tap **Save**.
 - d. Repeat steps b and c for all remaining 3D channels.
3. Measure the color gamut and create a measured color file.

4. Edit the channel values for your theatre. The predefined 3D Channels are named: **3D Flat 1998x1080** and **3D Scope 2048x858**.
5. Run test patterns to verify the performance of the new 3D channel formats.
6. Run 3D content to verify correct left and right eye data.

4.14.4 Edit the Default 3D Lamp File

For 3D images to display correctly, you must edit the default 3D lamp file to match the specifications of your 3D hardware.

1. Tap **Menu > Advanced Setup > Lamp Power / LiteLOC™ Setup**.
2. Select **Default** in the **Current Lamp File** list.
3. Set the brightness percentage for the lamp in the **Power%** field.
4. Tap **Save**.

4.14.5 Define a Measured Color Gamut Data File

For 3D images to display correctly, you must define an MCGD file to match the specifications of your 3D hardware.

1. Tap **Menu > Advanced Setup > MCGD File Setup**.
2. Hold a pair of 3D glasses in front of the light meter to determine the new x and y color coordinates for Red, Green, Blue, and White. Use the same light path that you use to display a show.
3. Enter the x and y values in the **Red, Green, Blue** and **White** fields.
4. Tap **Save As**.
5. Enter **3D Onsite** in the **File Name** field.
6. Tap **Save**.

4.14.6 Edit the 3D Flat 1998 x 1080 Channel

1. Tap **Menu > Channel Setup**.
2. Select **3D Flat 1998x1080** in the **Channel Name** list.
3. Tap **Config 1** in the left pane and edit these settings:
 - a. Select **292-Dual** in the **Input** list.
 - b. Select **YCrCb 4:2:2 10 bits x2** in the **Data Format** list.
 - c. Select **1998x1080 1.85 Flat** in the **Source File** list.
 - d. Select **Flat** in the **Screen File** list.
4. Tap **Config 2** in the left pane and edit these settings:
 - a. Select **3D Onsite** in the **Measured Color** list. If this option is not available, see Section 4.14.5: Define a Measured Color Gamut Data File.
 - b. Select **DC28_DCIXYZE_314_351** in the **Target Color** list.
 - c. Select **YCxCz Inverse ICT** in the **Color Space** list.
 - d. Select **Gamma 2.6** in the **Gamma** list.
 - e. Select **Linear_9x9x9** in the **LUT-CLUT** list.

5. Tap **3D Control** in the left pane and edit these settings:
 - a. Select **Line Interleave** in the **3D Sync Input Mode** list.
 - b. Select **6:2** in the **Frame Rate N:M** list.
 - c. Select **Left (L1R1 L2R2)** in the **L/R Display Sequence** list.
 - d. Select **True** in the **3D Sync Polarity** list.
 - e. Enter **430** in the **Dark Time** field or enter a value appropriate for your 3D hardware.
 - f. Enter **-120** in the **Output Delay** field or enter a value appropriate for your 3D hardware.
 - g. Enter **0** in the **Phase Delay** field or enter a value appropriate for your 3D hardware.

4.14.7 Edit the 3D Scope 2048 x 858 Channel

1. Tap **Menu > Channel Setup**.
2. Select **3D Scope 2048x858** in the **Channel Name** list.
3. Tap **Config 1** in the left pane and edit these settings:
 - a. Select **292-Dual** in the **Input** list.
 - b. Select **YCrCb 4:2:2 10 bits x2** in the **Data Format** list.
 - c. Select **2048x858 2.39 Scope** in the **Source File** list.
 - d. Select **Scope** in the **Screen File** list.
4. Tap **Config 2** in the left pane and edit these settings:
 - a. Select **3D Onsite** in the **Measured Color** list. If this option is not available, see Section 4.14.5: Define a Measured Color Gamut Data File.
 - b. Select **DC28_DCIXYZE_314_351** in the **Target Color** list.
 - c. Select **YCxCz Inverse ICT** in the **Color Space** list.
 - d. Select **Gamma 2.6** in the **Gamma** list.
 - e. Select **Linear_9x9x9** in the **LUT-CLUT** list.
5. Tap **3D Control** in the left pane and edit these settings:
 - a. Select **Line Interleave** in the **3D Sync Input Mode** list.
 - b. Select **6:2** in the **Frame Rate N:M** list.
 - c. Select **Left (L1R1 L2R2)** in the **L/R Display Sequence** list.
 - d. Select **True** in the **3D Sync Polarity** list.
 - e. Enter **430** in the **Dark Time** field or enter a value appropriate for your 3D hardware.
 - f. Enter **-120** in the **Output Delay** field or enter a value appropriate for your 3D hardware.
 - g. Enter **0** in the **Phase Delay** field or enter a value appropriate for your 3D hardware.

4.14.8 Display 3D Diagnostic Test Patterns

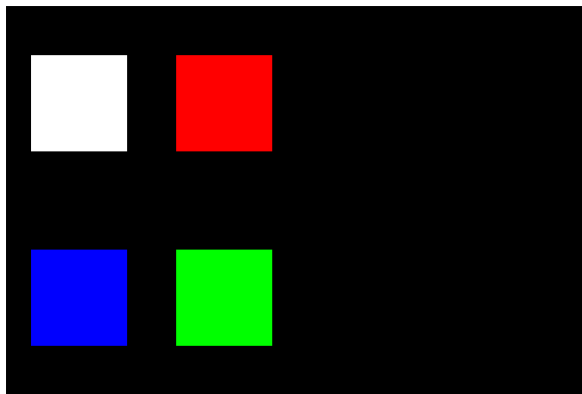
You can use 3D test patterns to verify your 3D hardware is functioning correctly.

1. Tap **Menu > Channel Setup**.
2. Select a 3D channel in the **Channel Name** list.

3. Tap **3D Test Patterns**.
4. Tap a test pattern.
5. Put on a pair of 3D glasses.
6. Look at the on-screen image, and then close your left eye and look at the image through your right eye. Switch when the image alternates.

3D Test Pattern	Action
RGB-12bit -3D Dynamic Range	Alternates between 2 images shown in Figure 4-10 .
RGB-12bit-3D Four Quadrant	Alternates between 2 images shown in Figure 4-11 .
RGB-12bit-3D Full White	Alternates between 2 100% white images.
RGB-12bit-3D Half Descending	Alternates between 4 images shown in Figure 4-12 .
RGB-12bit-3D Horizontal Ramp	Alternates between 2 horizontal ramp images.
RGB-12bit-3D L-Pattern	Alternates between 2 images shown in Figure 4-13 .

100% black field with 100% white (TL), red (TR), green (BR), blue (BL) boxes



100% black field with 100% red (TL), white (TR), blue (BR), green (BL) boxes

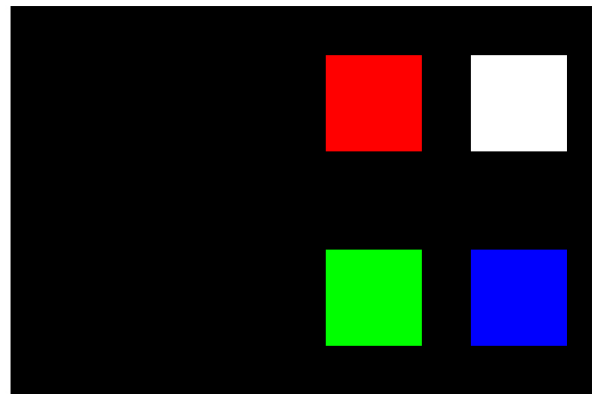


Figure 4-10 RGB-12 bit -3D Dynamic Range Test Pattern

**FRAME 1 - 100% white field box in
100% black field**



**FRAME 2 - 100% white field box in
100% black field**



**FRAME 3 - 100% white field box in
100% black field**

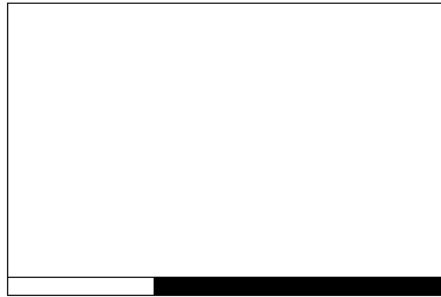


**FRAME 4 - 100% white field box in
100% black field**



Figure 4-11 RGB-12bit-3D Four Quadrant Test Pattern

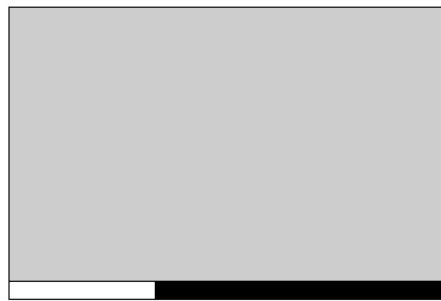
FRAME 1 - 100% white field with last lines 25% white and 75% black



FRAME 2 - 50% white field with last line 75% white and 25% black



FRAME 3 - 25% white field with last line 25% white and 75% black

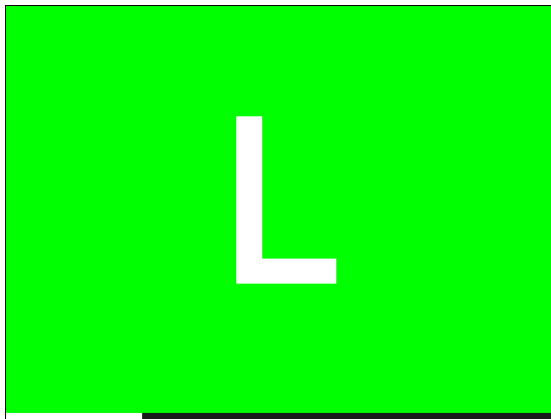


FRAME 4 - 12.5% white field with last line 75% white and 25% black



Figure 4-12 RGB-12bit-3D Half Descending Test Pattern

Green field with white “L” and last lines 25% white, 75% black



Magenta field with last lines 75% white, 25% black



Figure 4-13 RGB-12bit-3D L-Test Pattern

4.14.9 Verify 3D Cinema Content

1. Put on a pair of 3D glasses.
2. Play the 3D content.
3. Verify the left and right eye display correctly.
4. Put the 3D glasses on upside down.
5. If the image is reversed:
 - a. Tap **Menu** > **Channel Setup** on the projector Touch Pad Controller (TPC).
 - b. Select a 3D channel in the **Channel Name** list.
 - c. Select **Inverted** in the **3D Sync Polarity** list.

4.14.10 3D Troubleshooting

Reversed 3D Effect (Pseudo 3D)

1. Put your 3D glasses on upside down.
2. If the image is reversed:
 - a. Tap **Menu** > **Channel Setup** on the projector Touch Pad Controller (TPC).
 - b. Select a 3D channel in the **Channel Name** list.
 - c. Select **Inverted** or **True** in the **3D Sync Polarity** list.

Image Breakup

1. Tap **Menu** > **Channel Setup**.
2. Select a 3D channel in the **Channel Name** list.
3. Tap **3D Control** in the left pane.
4. Lower the **Dark Time** field value.

Image is Too Dark

The lamp power for 3D content is typically twice as high as for 2D content except when you are using a RealD XL device.

1. Tap **Menu** > **Advanced Setup** > **Lamp Power/LiteLOC™ Setup**.
2. Increase the value in the **Power%** field.

No 3D Effect

1. Tap **Menu** > **Channel Setup**.
2. Select a 3D channel in the **Channel Name** list.
3. Tap **3D Control** in the left pane.
4. Verify **Enable 3D** is selected.

Ghosting / Cross-talk

1. Tap **Menu > Channel Setup**.
2. Select a 3D channel in the **Channel Name** list.
3. Tap **3D Control** in the left pane.
4. Raise or lower the **Dark Time** field value.
5. Raise or lower the **Output Delay** field value.

Motion Artifacts

1. Tap **Menu > Channel Setup**.
2. Select a 3D channel in the **Channel Name** list.
3. Tap **3D Control** in the left pane.
4. Select **Left (L1R1 L2R2)** in the **L/R Display Sequence** list.

Disturbing Flashing in One Eye


1. Tap **Menu > Channel Setup**.
2. Select a 3D channel in the **Channel Name** list.
3. Tap **3D Control** in the left pane.
4. Select **Left (L1R1 L2R2)** in the **L/R Display Sequence** list.

5 Projector Operation


This section provides information and procedures for operating the projector.

5.1 Turn the Projector On

WARNING! Do not attempt to turn the projector on if the AC supply is not within the specified voltage range.

1. Turn the circuit breaker for the projector on.
2. On the Touch Panel Controller (TPC), tap and hold the green power icon.
3. On the TPC, tap and hold the light bulb  icon to ignite the lamp.

5.2 Turn the Projector Off

1. On the Touch Panel Controller (TPC), tap and hold the light bulb icon to turn the lamp off.
2. On the TPC, tap and hold the red power  icon. The projector enters a cool down mode and the fans and electronics stay on for 10 minutes. After this cool down period, the projector enters standby mode.
3. If you are servicing the projector, or removing the protective cover, disconnect AC and turn the breaker OFF.

5.3 Projector Power States

This table identifies what occurs when you press the Power and Lamp icons on the Touch Panel Controller (TPC).

		Projector's Current State:			
		Standby Power Mode (Solid Yellow)	Power ON/ Lamp OFF (Green Blip)	Power ON / Lamp ON (Solid Green)	Cooling Down Mode (Yellow Blip/ Green Blip)
TPC Buttons Clicked:	Power ON	To full power ON (boot delay)	No action	No action	Cancels cool down, goes into full power
	Power OFF	No action	Power OFF immediately	Lamp OFF (immediately), enters cool down mode	No action
	Lamp ON	To power ON and lamp ON (boot delay)	To lamp ON (immediately)	No action	Cancels cool down, goes to Lamp ON (immediately)
	Lamp OFF	No action	No action	Lamp OFF (immediately)	No action

5.4 Projector LED Status Indicators

Red, yellow, and green LEDs on the top and rear corners of the projector indicate the status of the projector. The LEDs can be solidly lit, or they can flash frequently or intermittently. This table lists the LED state and its associated meaning.

Table 5.1 Projector Status LED Legend

LED	State	Description
Solid Green	Lamp ON	Power is ON, Lamp is ON.
Green Blip	Power ON	Power is ON, Lamp is OFF. The lamp can be struck when in this mode.
Solid Yellow	Standby mode	Power is OFF, Lamp is OFF. Power saving mode.
Yellow Blip/ Green Blip	Cool down mode	Transitioning to STANDBY mode. Power is ON, Lamp is OFF. The lamp can be struck when in this mode.
Flashing Red	New critical alarm or warning	New critical alarm or warning has NOT been acknowledged by operator.
Solid Red	Existing critical alarm or warning	Critical alarm or warning exists, but has been acknowledged by operator.

5.5 Work with the Lamp

This section provides information and procedures for optimizing lamp performance. Optimizing lamp performance can ensure you receive the brightest, most uniform image possible for the life of the lamp.

5.5.1 Turning the Lamp On

1. Turn on the circuit breaker for the projector.
2. On the Touch Pad Controller (TPC) press and hold the green power icon for two seconds.
3. On the TPC, press and hold the lamp on icon for 2 seconds.

5.5.2 Turn the Lamp Off

1. On the Touch Pad Controller (TPC), press and hold the lamp off icon for two seconds.
2. On the TPC, press and hold the power off icon for two seconds.
3. Disconnect the projector from AC power and turn the projector circuit breaker off.

5.5.3 Adjust Lamp Power

1. Tap **Menu > Advanced Setup > Lamp Power/LiteLOC Setup**.
2. Increase or decrease the **Power%** value.
3. Tap **Set Target**.
4. Select **Enable LiteLOC™**.

5.5.4 Change the Lamp Power Percentage

Entering a new Lamp Power percentage temporarily disables LiteLOC settings.

1. Tap **Menu > Advanced Setup > Lamp Power/LiteLOC Setup**.
2. Increase or decrease the **Power%** value.

5.5.5 Use LampLOC™ to Adjust the Lamp Position

To ensure optimal lamp performance and peak brightness at the screen for the life of the lamp, use LampLOC™ to adjust the lamp position when you install a new lamp in the projector. After making the adjustment, the lamp is well-centered and distanced correctly from the remainder of the illumination system. Before adjusting LampLOC™, ensure the following criteria are met:

- The lamp must be ON and the douser (shutter) OPEN during adjustment. *A 10-minute warm-up is recommended. Ensure to follow all the criteria specified in Section 5.1 Turn the Projector On.*
- Perform a white test pattern. This is recommended to allow you to view LampLOC™ progress on-screen.

To automatically adjust LampLOC™:

1. Tap **Menu > Advanced Setup > LampLOC™ Setup**.
2. Tap **Do Auto**.

5.5.6 Manually Adjust the Lamp Position

1. On the **Main** screen of the TPC, tap the test patterns button.
2. Tap **RGB-12bit-Full Screen White**.
3. Mount a light meter on a tripod and center it with the lens. The distance from the lens does not matter. You may need an attenuator or an internal foil aperture.
4. Tap **Menu > Advanced Setup > LampLOC™ Setup**.
5. Tap the directional arrows to adjust the value displayed in the **Z** field. The brightness reading in front of the lens should be maximized.
6. Tap the directional arrows to adjust the values displayed in the **X** and **Y** fields. The brightness reading in front of the lens should be maximized.
7. Repeat Steps 5-6, but take your readings at the screen instead of at the lens.
8. Run LiteLOC™ or LampLOC™ if required.

5.5.7 View Lamp Information

To view information on the lamps previously installed in the projector, or to add a new lamp:

Tap **Menu > Advanced Setup > Lamp History**.

5.5.8 Receive an Alarm when a Lamp Reaches Its Expiry Date

To receive an alarm when the lamp reaches its operational limit:

1. Tap **Menu > Administrator Setup > Preferences**.
2. Tap **Lamp Expiry** in the **Alarm Triggers** area.

Section 5: Projector Operation

5.5.9 Receive an Alarm when a Lamp Needs to be Rotated

To receive an alarm when the lamp reaches its operational limit:

1. Tap **Menu > Administrator Setup > Preferences**.
2. Tap **Lamp Rotation** in the **Alarm Triggers** area.

5.5.10 Lamp Expiry Hours

This table lists the maximum hours projector lamps can operate before replacement:

Table 5.2 Lamp Expiry Hours

Lamp Type	Replace BEFORE
CDXL-20 (2.0 kW)	3500 hours
CDXL-30 (3.0 kW)	2500 hours
CDXL-30SD (3.0 kW)	2000 hours when operating at 2.5 kW 1100 hours when operating at 3.0 kW

5.5.11 Minimum and Maximum Lamp Power Ratings

This table lists the minimum and maximum power settings for projector lamps:

Table 5.3 Minimum and Maximum Lamp Power by Lamp Type

Lamp Type	Lamp Size	Min Lamp Power	Max Lamp Power
CDXL-20	2 kW	1000W (50%)	2200W (110%)
CDXL-30	3 kW	1800W (60%)	3300W (103%)
CDXL-45	4.5 kW	2700W (60%)	4950W (110%)
CDXL-60	6.0 kW	3600W (60%)	6600W (110%)
CDXL-60SD	7.0 kW	3600W (51%)	7100W (101%)*

* The maximum power of the lamp power supply is restricted to 7000W ± 100W.

5.6 Work with Lenses

The lens mount secures the primary zoom lens to the projector and provides setup adjustments for correct boresight, and manually controlled focus, zoom and offsets. See [6. Adjust optical components if required., on page 2-17](#) for lens installation and boresight instructions.

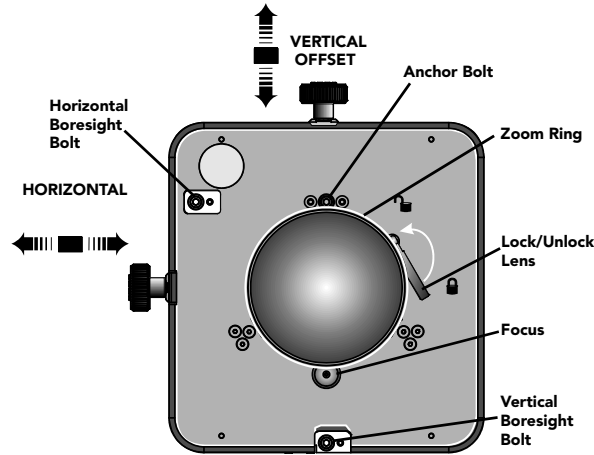


Figure 5-1 Lens Mount

The optional Intelligent Lens System (ILS) automates the process of adjusting the Focus, Horizontal (X) and Vertical (Y) Offset, and Zoom in real-time using a motorized lens mount. ILS settings are saved in a file named **ILS Flat** or **ILS Scope**.

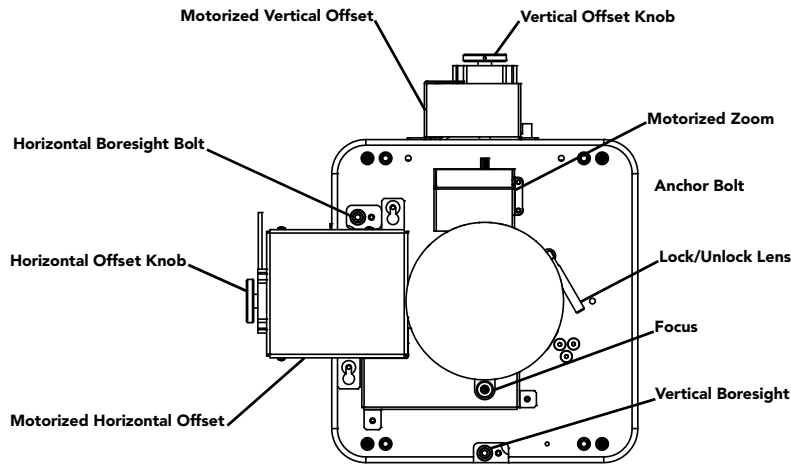


Figure 5-2 Anatomy of the Lens Mount

An anamorphic lens (1.25x) can be installed into the optional auxiliary lens mount, then swung into place in front of the primary lens to widen a “squeezed” image into a properly proportioned “scope” anamorphic cinema display. It is typically used in theatres having side masks that are retracted for “scope” images, or in theatres having fixed side masking but a very short throw ratio.

5.6.1 Enable Automatic ILS Selected

When the **Enable Automatic ILS** check box is selected, the ILS adjusts each motor for the focus, offset, and zoom to automatically move the lens based on the settings in the selected ILS file. Changing channels will

change the position of the lens, assuming the new channel uses a different ILS file. To make adjustments to an ILS file, use the motorized lens mount adjustment features in the **Advanced Setup: ILS File Setup** window or **Lens Adjust** window from the **Main** panel to adjust the focus, zoom and offset values. For more information, see [6.14.4 ILS File Setup Window](#). **NOTE:** *Any changes made to the focus, offset and zoom values will overwrite the current values in the ILS file, therefore these changes will affect every channel that uses this ILS file.*

5.6.2 Enable Automatic ILS NOT Selected

When the **Enable Automatic ILS** check box is NOT selected, the lens does not move unless you make adjustments to the focus, offset and zoom from the **Lens Adjust** window launched from the **Main** panel (the **ILS File Setup** window is not available when the **Enable Automatic ILS** check box is not selected). These settings will NOT overwrite the ILS values and changing channels will not affect the position of the lens.

The following table provides an example of what happens to the lens position and saved ILS Flat values when you adjust the focus, zoom, and offset in both states of the Enable Automatic ILS feature.

Table 5.4 Example - ILS Flat Values and Lens Position with Enable Automatic ILS

	Starting Position	Adjust ILS Flat Values with Enabled Automatic ILS Selected			Adjust ILS Flat Values with Enabled Automatic ILS NOT Selected		
	Original ILS Flat Values	Adjusted Lens Position	ILS Flat Values (New positions are saved to the ILS file)	Change to a Channel with ILS Scope Values (Changing channels changes the lens position)	Adjusted Lens Position	Lens Position ILS Flat Values (New positions are not saved to the ILS file)	Change to a Channel with ILS Scope Values (Changing channels does not change the lens position)
Focus	-155	-200	-200	0	-200	-155	-200
Zoom	100	125	125	25	125	100	125
Horizontal Offset (x)	0	35	35	15	35	0	35
Vertical Offset (y)	256	375	375	200	375	256	375

Using the offset, focus, and zoom knobs on the lens mount does not save the settings to the ILS file. These settings will be lost once the **Enable Automatic ILS** check box is selected in the **Advanced Setup: Lens Adjust** window.

5.6.3 Access the ILS

On the **Main** screen of the TPC, tap **Advanced Setup > ILS File Setup**.

5.6.4 Enable ILS on a Channel

1. On the **Main** screen of the TPC, tap a channel.
2. Tap the **Test Patterns** button and then tap a test pattern.

3. On the **Main** screen of the TPC, tap **Lens Adjust**.
4. Tap **Enable Automatic ILS** to automatically apply the active channel settings.

5.6.5 Alter the Active ILS Settings

1. On the **Main** screen of the TPC, tap **Lens Adjust**.
2. Tap **Enable Automatic ILS**.
3. Tap the directional arrows to adjust the values displayed in the **X**, **Y**, and **Zoom** fields. These values over-write the ILS settings.

5.6.6 Maintain Lens Position Regardless of Selected Channel

1. On the **Main** screen of the TPC, tap **Lens Adjust**.
2. Clear the **Enable Automatic ILS** check box.
3. Tap **OK**.
4. Adjust the focus, Horizontal (X) and Vertical (Y) offset, and zoom by tapping the applicable button.
NOTE: *This does not over-write the system settings for the ILS. If **Enabled Automatic ILS** is selected again, the ILS will position the lens to the saved channel settings.*
5. If the **Quick Reset** or **Lens Calibration** buttons are tapped in the **Advanced Setup: Lens Setup** window, the lens returns to this remembered location. Also, this setting is remembered across system resets and reboots.

5.6.7 Reset the ILS

The ILS must be reset when:

- the lens has been moved
- manual adjustments have been made to horizontal or vertical offset, zoom or focus
- a power outage occurred during a channel change
- ILS settings are drifting within a short period of time

1. On the **Main** screen of the TPC, tap **Lens Adjust**.
2. Tap **Quick Reset**. If **Enable Automatic ILS** is not selected, the lens returns to the stored settings.

5.6.8 Calibrate the ILS

You must calibrate the ILS must when you install a new lens.

1. On the **Main** screen of the TPC, tap **Lens Adjust**.
2. Tap **Full Calibration**. If **Enable Automatic ILS** is not selected, the lens returns to the stored settings.

5.7 Present Movies

This section provides information and procedures for using the projector to present movies. It is recommended that you read through this section in its entirety before displaying movies for the first time. Before you display movies for the first time, verify that the projector is properly installed, aligned, and configured. See [Section 2 Installation and Setup](#).

5.7.1 Connecting Sources

Connect a digital media storage device or cinema server to one of the 292A or 292B input ports. For a list of standard single-link SMPTE 292M Formats, see [Section Appendix A: Specifications](#).

5.7.2 Using an Anamorphic Lens

The standard zoom lens on the projector can display flat images because the native resolution and format of the projector closely match the flat aspect ratio. The installation of an optional anamorphic lens requires that the source material is resized to fill the digital micromirror device (DMD) and the pixels are horizontally stretched so that the full 2.39 image width appears on-screen.

For Screens 60ft or Larger

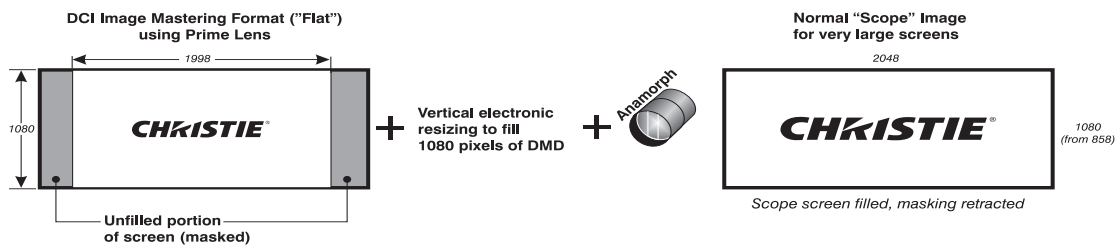


Figure 5-3 Using Anamorphic Lens to Achieve "Scope" for Large Screens

5.7.3 Using a Wide Converter Lens

The optional Wide Converter Lens (WCL) magnifies a flat image with a format of 1.85:1 to a scope image with a 2.39:1 format, while maintaining the full resolution of the source material.

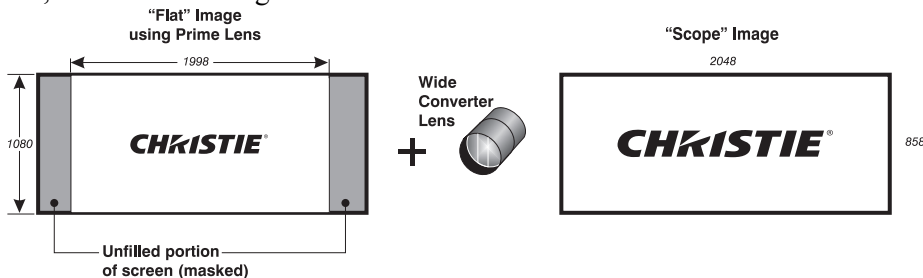


Figure 5-4 Using Wide Converter Lens to Achieve "Scope" with No Resizing

5.7.4 Masking

You use masking to conceal the unused edges of a screen. These are the two types of masking:

- Top Masking – Movable flat black panels or curtains are installed along the top edge of the screen. You raise the curtain for flat images, and you lower the curtain for scope images.
- Side Masking – Movable flat black panels or curtains are installed on each side of the screen. You close the curtain for flat images, and open the curtain for scope images.

Typically, you install top and side masking to allow a greater range of adjustment.

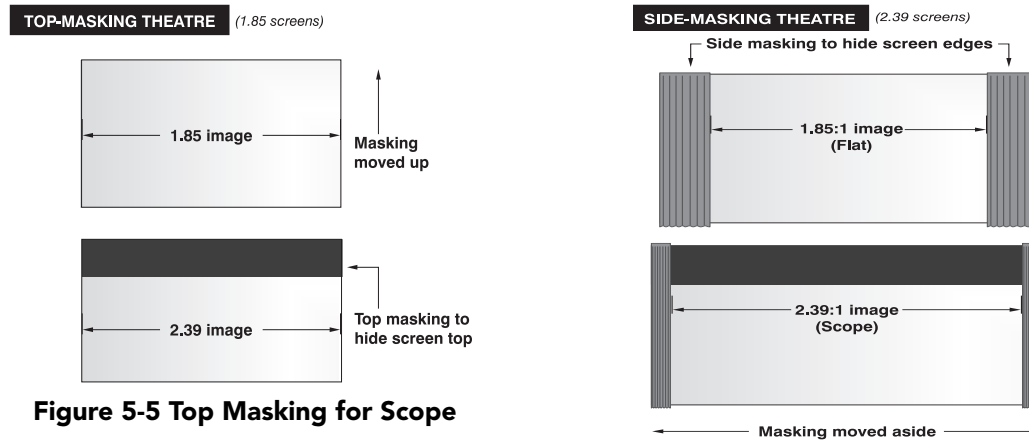


Figure 5-5 Top Masking for Scope

5.8 Display Non-Cinema Content

To display content from standard or high definition non-cinema sources, connect the source to the DVI-D A and DVI-D B ports on the input panel. The DVI port auto-detects progressive scan and digital RGB sources and displays them in their original format. Using two DVI ports as a higher-bandwidth dual-link or twin-link pair is not supported. For a list of compatible non-cinema DVI sources, see [Section Appendix A: Specifications](#).

5.9 Selecting a Source

The projector uses pre-configured channels to determine how to display images from different sources. Each channel file contains the optimum processing and display settings for the source. You select channels on the Main Touch Pad Controller (TPC) screen. If the channel you need is not listed on the Main panel, click All.

6 Projector Menus

This section provides information and procedures for using projector menus. You can use projector menus to adjust projector settings and view status information.

6.1 The Touch Panel Controller (TPC)

The TPC is a touch-sensitive screen that you use to control the projector. You can use the TPC to turn the projector and lamp on or off, select channels, and view status information. The TPC is mounted on the rear of the projector. You can tilt and turn the TPC to improve the viewing angle. There are two USB ports under a cover on the rear of the TPC that you can use to download log files and install software upgrades. You can disconnect the TPC from the projector and an optional cable allows you to control the projector from a maximum distance of 100 feet.

If the TPC fails or is disconnected, press the emergency start button that is recessed on the faceplate. This starts the projector, turns the lamp on, and opens the douser.

6.2 Main Screen

Use the Main screen of the Touch Panel Controller (TPC) to access power, lamp, douser, auxiliary lens, lens adjust, and test pattern settings. You can also select channels.

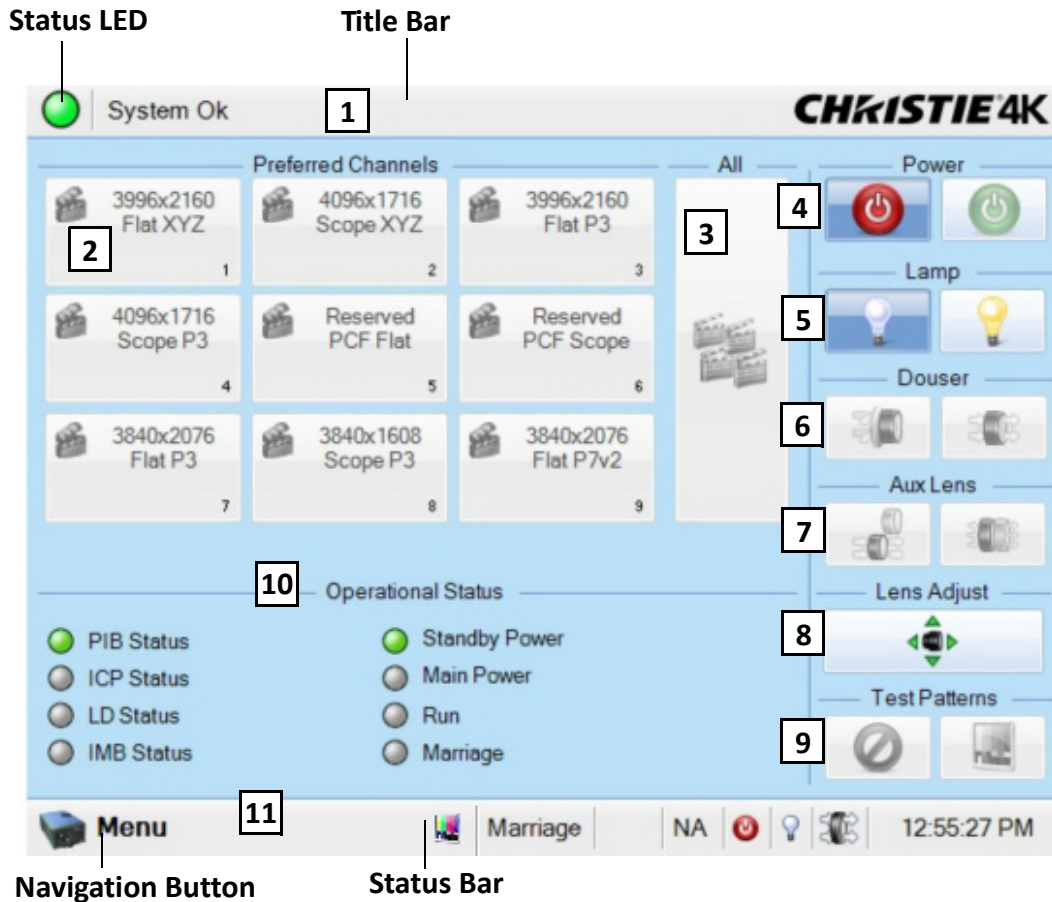













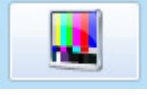
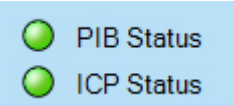





Figure 6-1 Main Panel


Table 6.1 Main Panel

Control	Description
1: Title Bar * Status LED  Status Error Message  Critical alarm exists	Displays a green, yellow, or red LED. A green LED indicates that the projector is operating properly. If a monitored system falls below a normal reading, the LED is yellow or red. A yellow LED indicates a warning, and a red LED indicates a critical error that you must correct. Click the status LED to open the Status window and resolve issues. For information about the Status window, see 6.5 Status Window, on page 6-7 .
2: Channels Buttons 	Displays custom projector settings.

Control	Description
3: All Channels Button	Displays 64 saved channels.
4: Power Power OFF Power ON  	Turns the projector on or off. Press off to place the projector in stand-by mode. To prevent accidental activation, you must press and hold the on or off buttons. A message displays in the title bar when the projector turns on or off.
5: Lamp Lamp OFF Lamp ON  	Turns the lamp on or off. To prevent accidental activation, you must press and hold the on or off buttons. A boot delay occurs if you select lamp on before pressing power on.
6: Douser Douser Closed Douser Opened  	Opens or closes the douser.
7: Aux Lens Aux Lens OUT Aux Lens IN  	Engages or disengages the auxiliary lens. If the auxiliary lens mount is not installed, the Aux Lens buttons are disabled. Engaging the auxiliary lens temporarily overrides the position settings defined in the Config 1 channel.
8: Lens Adjust 	Controls the Intelligent Lens System (ILS) lens motors. Press to open the ILS Adjust window. If the Intelligent Lens System is not installed, the Lens Adjust button is not available.
9: Test Patterns Disable Select Test Pattern  	Selects or disables test patterns. Press Select Test Pattern to open the Preferred Test Patterns window.
10: Operational Status 	Displays the status of projector functions including the Projector Intelligence Board (PIB), TI Electronics the Integrated Cinema Processor Board (ICP), Link Decrypter (LD), Internal Media Block (IMB), Standby Power, Main Power, Run, and Marriage. A green LED indicates the system is functioning correctly. A red LED indicates a critical error that you must correct. Click the status LED to open the Status window and resolve issues.

Control	Description
11: Status Bar* Menu Button  Status  Select Test Pattern 	The Menu button is the starting point to the user windows. Tapping this button opens a 2 layer menu system populated with available windows based on your permission level. The bottom right corner of every window shows the logged in user, the active channel, as well as the status of the Power, Lamp, Douser and Aux Lens. These icons change as these elements update from changes on the projector. The current time also displays. Tapping the Select Test Pattern button launches the Preferred Test Patterns window for you to choose a test pattern to display.

6.3 Open the On Screen Keyboard

Tap the **Launch Dialog** button () to open the On Screen Keyboard. The Onscreen Keypad is only available when you need to enter numerical values.

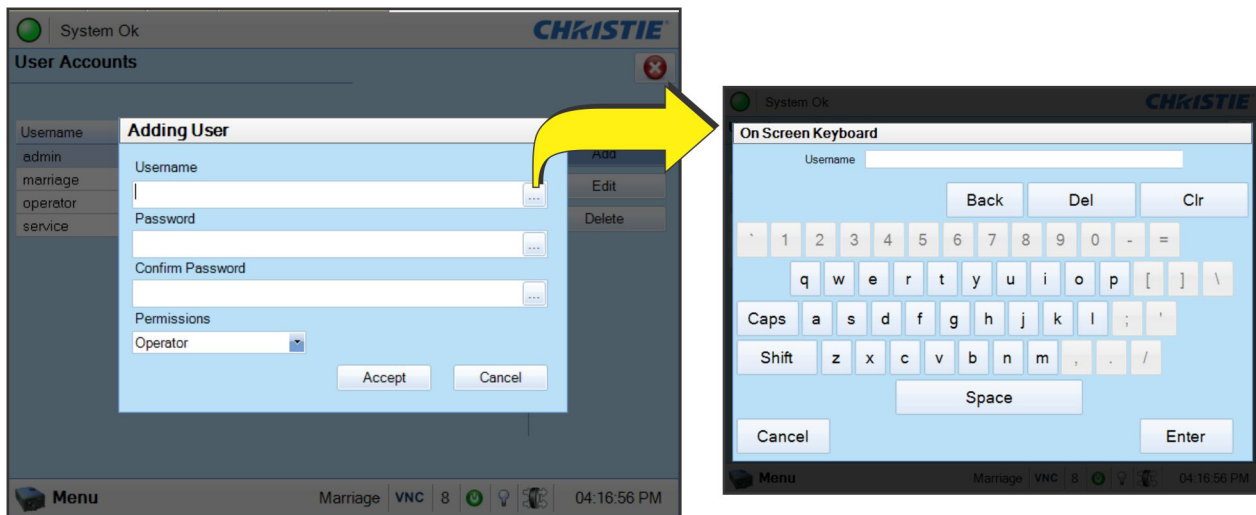


Figure 6-2 On Screen Keyboard

6.4 User Access and Rights

This table lists the Touch Panel Controller (TPC) permissions:

Table 6.2 User Levels

Permission Level	Description
Status	Any user can view basic projector status, diagnostic information and software version information. This is the default level for Serial Communication sessions.
Operator	This level of user can activate channels and test patterns, view detailed diagnostic logs for in-depth troubleshooting and view server errors. This is the default level at the TPC.
Advanced	This level of user can define all display setups such as source resolution, aspect ratio, image cropping, and color gamut information, optimize light output, record lamp changes, and define setup files as selectable choices for processing a variety of incoming signals.
Administrator	This level of user can perform screen Foot Lambert calibration, define Ethernet settings (IP network address), restore backup files, and upgrade the system software. NOTE: <i>Administrators can add users and set user access rights from its own level and below only.</i>
Service	Installers and other service personnel can access all windows on the TPC, which includes performing Marriage.
Marriage	Installers and other service personnel can access all windows on the TPC, which includes performing Marriage.

Table 6.3 Accessible Windows per User Level

Menu	Status	Operator	Advanced	Administrator	Service	Marriage
Main	X	X	X	X	X	X
Status	X	X	X	X	X	X
Diagnostics - Interrogator - SMPTE Errors - System Logs - Server Test - DLP Management		X (except DLP Management)	X (except DLP Management)	X	X	X
Network Devices	X	X	X	X	X	X
Channel Setup - Config 1 - Config 2 - 3D Control			X	X	X	X

Menu	Status	Operator	Advanced	Administrator	Service	Marriage
Advanced Setup - Lamp Power / LiteLOC™ Setup - Lamp Change Wizard - Lamp History - LampLOC™ Setup - ILS File Setup - Lens Setup - Source File Setup - Screen File Setup - MCGD File Setup - TCGD File Setup			X	X	X	X
Administrator Setup - Preferred Channel Setup - Preferred Test Pattern Setup - Preferences - Content Devices Configuration - Time Setup - Communications Configuration - Network Devices Setup - GPIO Setup - Foot Lamberts Calibration - User Accounts - Upgrade				X	X	X
Service Setup - File Management - LD/IMB Marriage - System Access				X (except Marriage)	X (except Marriage)	X
About	X	X	X	X	X	X
Help	X	X	X	X	X	X

6.5 Status Window

You use the Status window to view projector status information. To view the Status window, tap **Menu > Status**.

The right pane displays a list of projector items and their status. The left pane provides detailed information about individual projector items.

A green LED indicates the item is functioning correctly. A yellow LED is a warning that a projector item requires attention. A red LED indicates a projector item requires immediate attention.

If the **Item** or **Value** descriptions are too long for the cell, click the description to view the full description at the bottom of the window. To adjust the width of a column in the left pane, click and drag the column border. When you close the Status window, the column widths return to their default size.

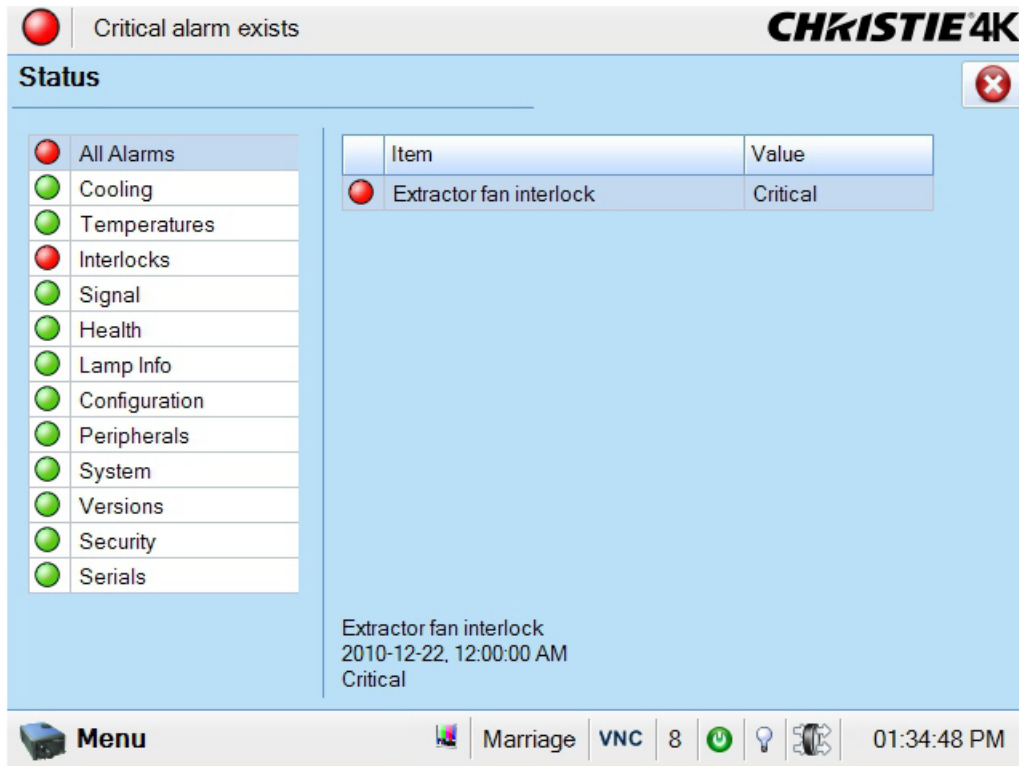


Figure 6-3 Status Window

Table 6.4 Summary of Status: System Components

All	
Displays all the status items that are in alarm state.	
Cooling	
Cooling Pump	
Card Cage Fanpack (bottom right)	
Card Cage Fanpack (top right)	
Intake Fanpack (bottom right)	
Intake Fanpack (bottom left)	
Intake Fanpack (top right)	
Intake Fanpack (top left)	
LAD Fan	
Radiator	
Card Cage Exhaust (Operator side)	
Card Cage Exhaust (Non-Operator side)	
Lamp Power Supply Fan	
Temperatures (degrees Celsius)	
Card Cage Exhaust	
Lamp Exhaust	65 °C = warning, \geq 75 °C = critical
Filtered Air Intake	
Integrator	90 °C = warning, \geq 100 °C = critical
Prism	60 °C = warning, \geq 70 °C = critical
Blue DMD	63 °C = warning, \geq 68 °C = critical
Green DMD	63 °C = warning, \geq 68 °C = critical
Red DMD	63 °C = warning, \geq 68 °C = critical
ILS Board	
LampLOC™ Board	
EVB Board	
Lamp Power Supply	
FMT FPGA	
ICP FPGA	
ICP Board	
PIB	
Backplane	
Interlocks	
Extractor fan intake	OK/Failed
AC Blower	OK/Failed
Lamp Door	OK/Failed
Fire Alarm	OK/Failed
Signal	
Input Frequency	
Input Port	
Data Format	
LD Link0 State	
LD Link1 State	
LD Link2 State	
LD Link3 State	
Health	
292-A Total SMPTE Error Count	
292-A Recent SMPTE Error Count	
292-B Total SMPTE Error Count	
292-B Recent SMPTE Error Count	
CPLD Self Test	
PI Board Seated Properly	
RAM Self Test	
Flash Self Test	
LVDS Self Test	
LampLOC™ Main Code - CRC	
LampLOC™ State	
LampLOC™ X Sensor	
LampLOC™ Y Sensor	
LampLOC™ Z Sensor	

EVB Main Code - CRC	
EVB State	
LVPS AC OK	
LVPS DC OK	
Lamp Info	
Lamp ID	
Lamp Serial Number	
Lamp Power	Lamp power in watts
Lamp Current	Lamp current in amps
Lamp Voltage	Lamp voltage in volts
Luminance	Luminance in Foot Lamberts or Candela
Lamp Intensity	Current light intensity reading
Lamp Expired Status	Yes/No
Lamp Needs Rotation	Yes/No
Total Hours on Installed Lamp	Total number of hours on current lamp
Lamp State	On/Off
Configuration	
Projector model	Displays projector model
Projector serial number	Displays projector serial number
Date of manufacture	Displays manufacture date
Projector subtype	
Projector subtype ID	
Light engine native resolution	2048 x 1080
Lamp Power Supply ID	
IP Address	Displays IP address
Subnet mask	Displays subnet mask address
Gateway	Displays gateway address
Peripherals	
Auxiliary Lens Install Status	Yes/No
Auxiliary Lens Type	Type of auxiliary lens installed
ILS Install Status	Yes/No
ILS Main Code - CRC	
ILS Temperature	Displays ILS temperature in Celsius/Fahrenheit when ILS is installed
ILS Board ID	
ILS Boot Version	
ILS Software Version	
ILS Hardware Version	
ILS X Sensor	
ILS Y Sensor	
ILS Focus Sensor	
ILS Zoom Sensor	
ILS State	
System	
Hours on projector	
ICP State	
LD State	
Lamp Hours on projector	
Lamp Power Supply State	
Available Disk Space (MB)	
Disk space used (MB)	
Available Memory (KB)	
ICP 3.3v rail	
ICP 2.5v rail	
ICP 1.8v rail	
ICP 1.2v rail	
Versions	
Package Version	
TPC Software	
TPC OS	
EVB Main	
EVB Boot	
EVB Hardware	
IMCB ILS Boot	
IMCB ILS Main	
IMCB ILS Hardware	
IMCB Lamp Boot	
IMCB Lamp Main	
IMCB Lamp Hardware	

Section 6: Projector Menus

PIB LVDS FPGA	
PIB FPGA Production	
PIB FPGA Factory	
PIB Main Production	
PIB Main Factory	
PIB Bootloader	
PIB CPLD	
Router Bootloader	
Router Kernel	
Router Sysfs	
LD Security List	
LD Software	
LD Login List	
ICP Software	
ICP OS	
ICP Kernel	
ICP RAM Disk	
ICP Software Boot	
ICP Firmware Boot	
ICP Software Main	
ICP Firmware Main	
ICP Firmware FPGA Config	
ICP Secure Processor	
Formatter Software Boot	
Formatter Firmware Boot	
Formatter Software Main	
Formatter Firmware Main	
Formatter Satellite	
Formatter FPGA Config	
Formatter Sequence Data	
Formatter DMD Data	
PIB Mod ID.Rev.Level	Value displayed as PIB model ID. Revision Number. Level
Backplane Mod ID.Rev.Level	Value displayed as Backplane model ID. Revision Number. Level
Faceplate Mod ID.Rev.Level	Value displayed as Faceplate model ID. Revision Number. Level
SFB-Red Level Mod ID Board	
SFB-Blue Level Mod ID Board	
SFB-Green Level Mod ID Board	
Security	
Security Enclosure Armed	
Security Enclosure Tamper	
Security Enclosure Battery Low	
Bottom Enclosure Open	
Top Enclosure Open	
Log Error	
Log Warning	
Logical Marriage Tamper	
Physical Marriage Tamper	
LD Low Battery	
Marriage Active	
Projector Security Lid Tamper	
The certificates on the LD have been zeroized	
ICP-LD Communication Error	
Serials	
LD	
ICP	
Projector	
Backplane	
PIB	
EVB	
LampLOC™ Board	
ILS Board	
Primary Lens	
Auxiliary Lens	
Lamp	
Lamp Power Supply	

6.6 Alarm Window

When an alarm occurs, an Alarms window with a red border appears with a description of the alarm condition, state, and time and date of the alarm. The window only displays alarms you have not previously acknowledged. To acknowledge an alarm and remove it from the Alarms window, click **Acknowledge**. To view all alarms, tap **Menu > Status > All Alarms** in the left pane.

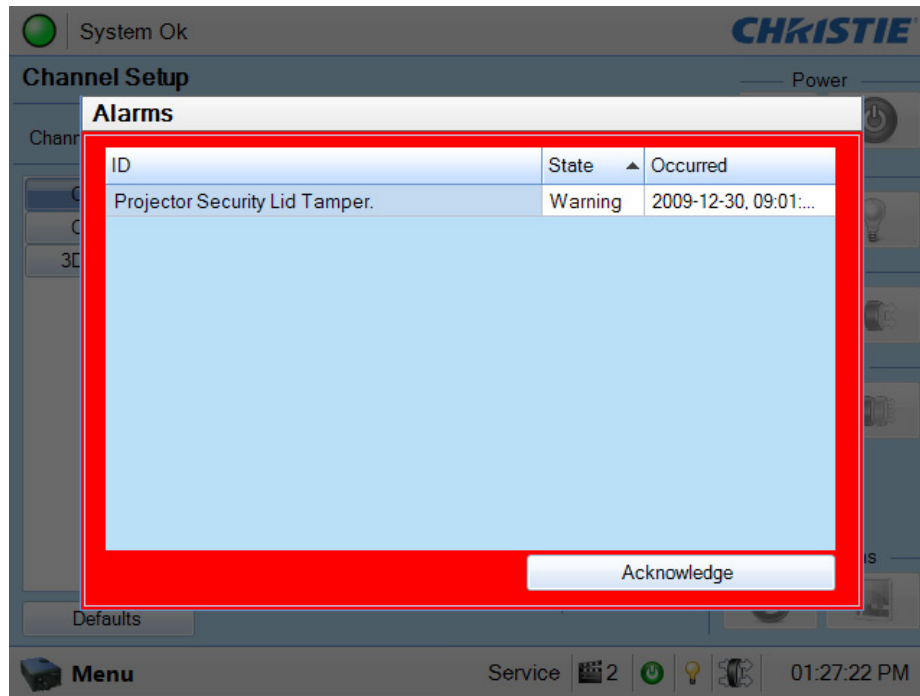


Figure 6-4 Alarm Window

6.7 Interrogator Window

To open the Interrogator window you need Operator, Administrator, or Service permissions. Tap **Menu** > **Diagnostics** > **Interrogator**.

When you run the interrogator, you cannot modify projector settings. Image disruption can occur if you run the interrogator during a show. If a failure occurs, run the interrogator to capture valuable diagnostic information before you correct the issue or restart the projector.

Use the Interrogator window to retrieve log files and current configuration information in a single file. Select **Basic Mode** to return log files, or select **Enhanced Mode** to return log files and registered batch files. Select **Download to USB** to copy the log and batch files to a USB drive.

NOTE: Log files are compressed into a 7z or 7-zip file format. A tool for opening these archives can be downloaded from <http://www.7-zip.org>.

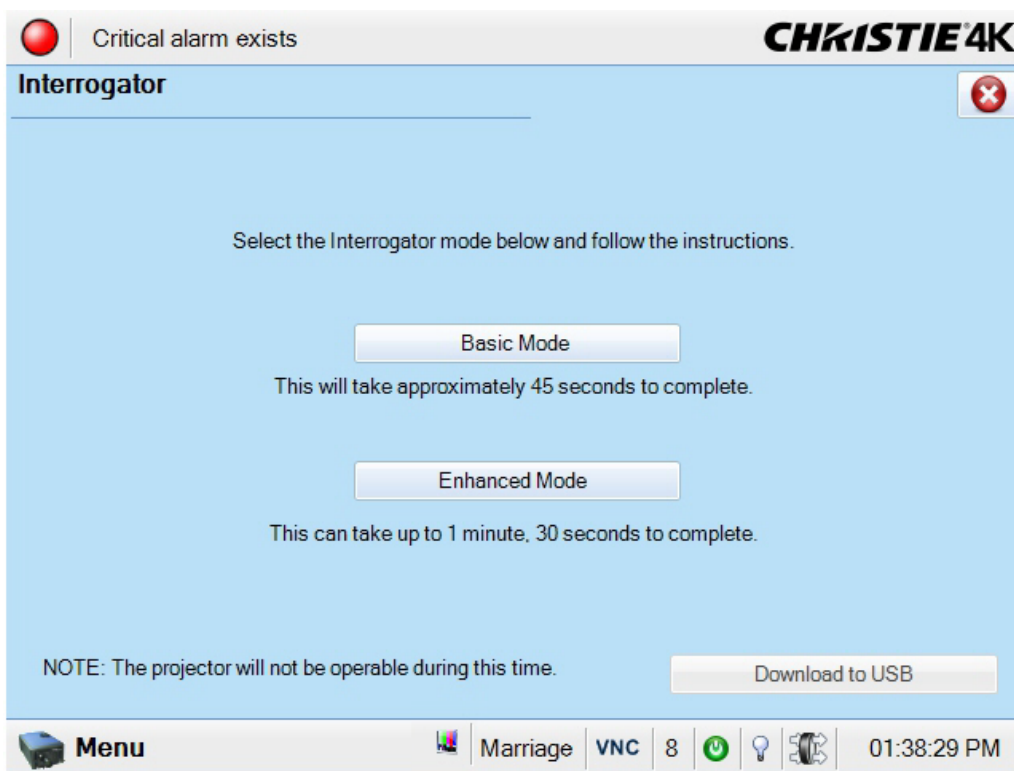


Figure 6-5 Diagnostics: Interrogator Window

6.8 SMPTE Errors Window

To open the SMPTE Errors window you need Operator, Administrator, or Service permissions. Tap **Menu > Diagnostics > SMPTE Errors**.

The SMPTE Errors window displays a numerical representation of the signal integrity of the HD-SDI signals sent to the projector on the BNC signal cables. Click Clear Errors to clear all errors.

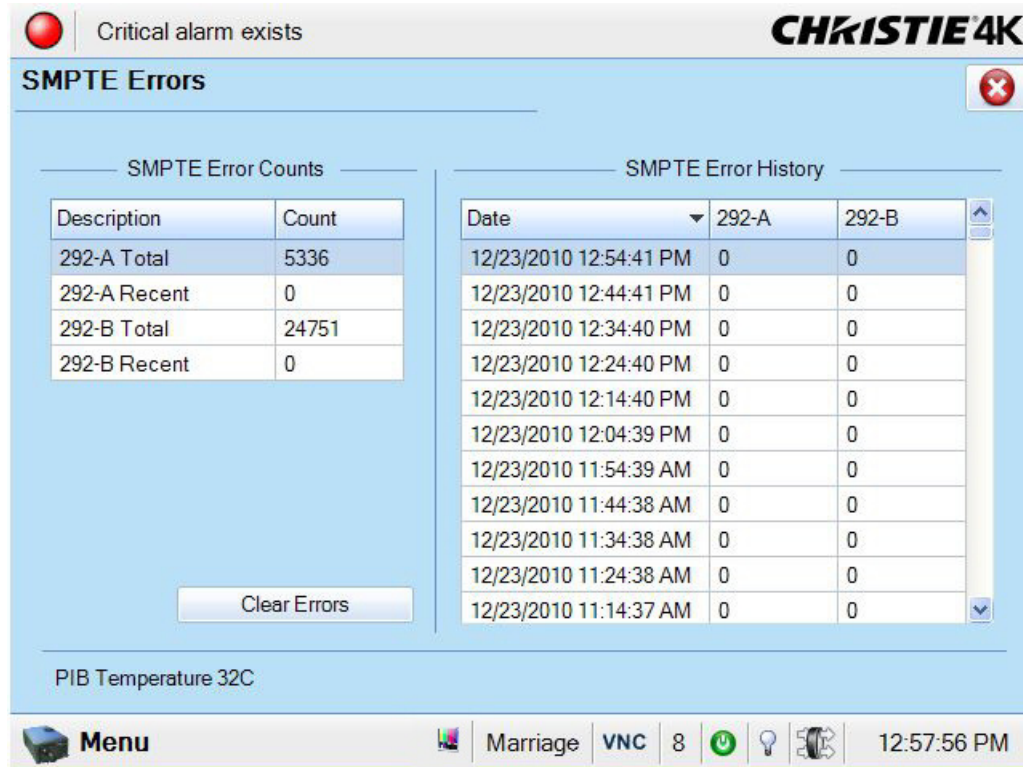


Figure 6-6 Diagnostics: SMPTE Errors Window

Table 6.5 Diagnostics: SMPTE Errors Window

Region	Control	Description
SMPTE Error Counts	292-A Total	The total count of 292-A errors.
	292-A Recent	The recent count of 292-A errors.
	292-B Total	The total count of 292-B errors.
	292-B Recent	The recent count of 292-B errors.
	Clear Errors	Resets SMPTE Error Counts to 0. This is used for testing to see if the error returns.
SMPTE Error History		A history of SMPTE errors.
Card Cage Temperature		The card cage temperature to easily diagnose if this is causing the SMPTE errors.
Refresh		Returns a list of SMPTE errors.

6.9 System Logs Window

To open the System Logs window you need Operator, Administrator, or Service permissions. Tap **Menu > Diagnostics > System Logs**.

Use the System Logs window to retrieve or download log files.

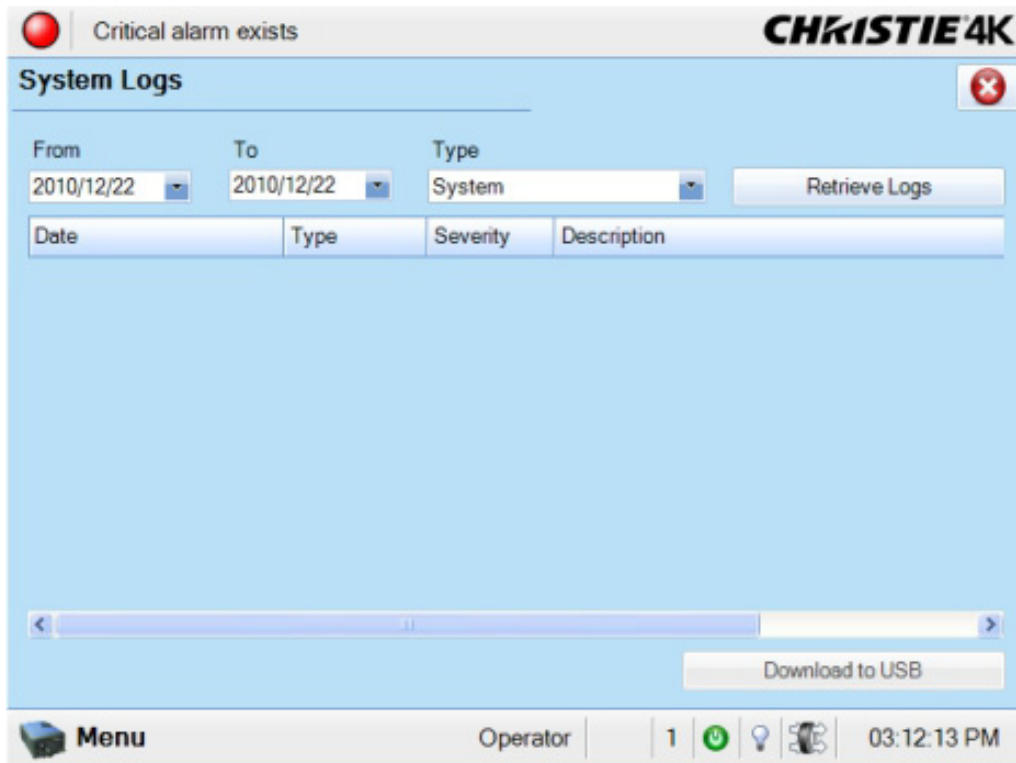


Figure 6-7 Diagnostics: System Logs Window

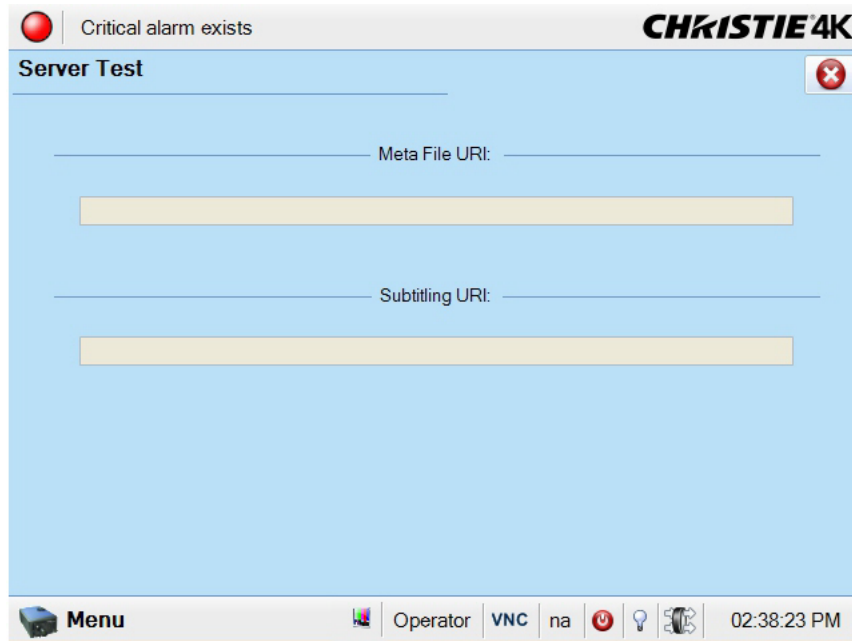
Table 6.6 Diagnostics: System Logs Window

Control	Description
From	The start date for the log file reporting period.
To	The end date for the log file reporting period.
Type	The type of log file to retrieve. These are the available options: All System Event Maintenance Operational Security Engineering

6.10 Server Test Window

To open the System Logs window you need Operator, Administrator, or Service permissions. Tap **Menu > Diagnostics > System Logs**

Use the Server Test window to test subtitle and meta data commands supplied with presentation content. You can search the subtitle and meta data .xml files for errors in content or in transmission from the server. The controls in the **Server Test** menu DO NOT turn meta data or subtitling OFF and ON.



Control	Description
Meta File URL	The URL of the Meta File (XML) for the current digital content.
Subtitling URL	The URL of Subtitling (XML) for the current digital content.

6.11 DLP Management Window

Use the DLP Management window to manage the TI Integrated Cinema Processor (ICP) electronics. Tap **Menu > Diagnostics > DLP Management**.

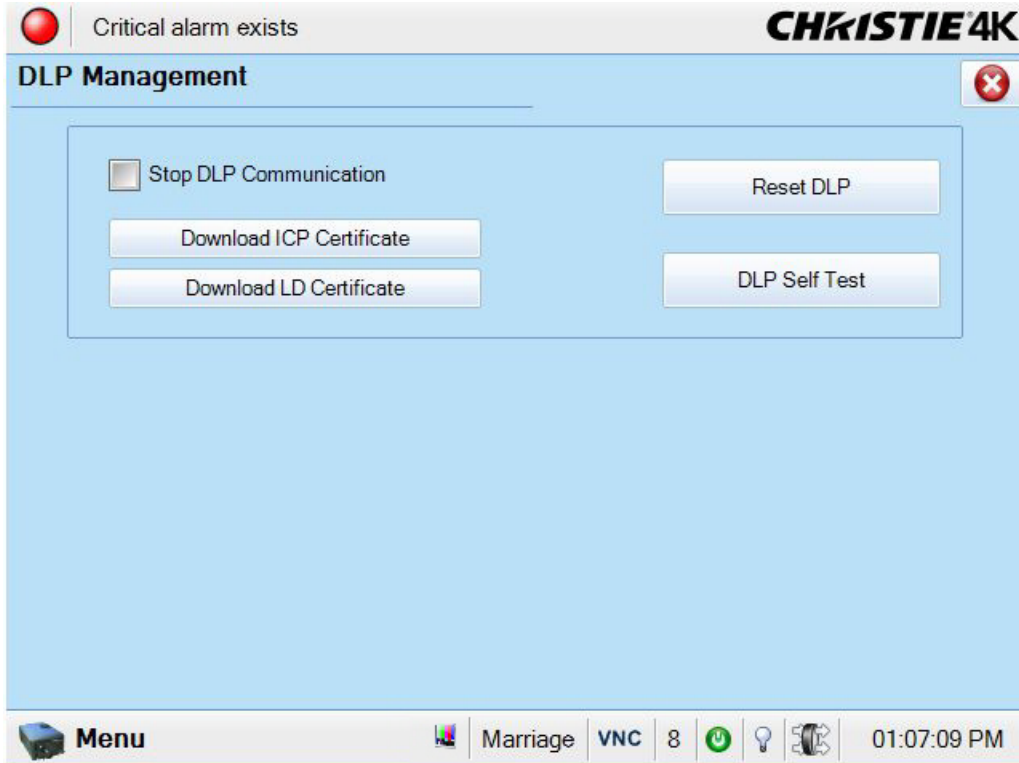


Figure 6-8 Diagnostics: DLP Management Window

Table 6.7 Diagnostics: DLP Management Window

Control	Description
Stop DLP Communication	Turns off communication to the DLP hardware (Integrated Cinema Processor and Link Decrypter).
Download ICP Certificate	Copies the ICP certificate to a file on the USB drive. If a USB drive is not available, the file is saved to the FTP root directory.
Download LD Certificate	Copies the LD certificate to a file on the USB drive. If a USB drive is not available, the file is saved to the FTP root directory.
Reset DLP	Resets the ICP board. Do not select this option when a movie is playing.
DLP Self Test	Runs ICP and LD self tests of the DLP hardware and returns the results on-screen.

6.12 Network Devices

The **Network Devices** menu only displays when you add a network device in the **Administrator Setup: Network Devices Setup** window.

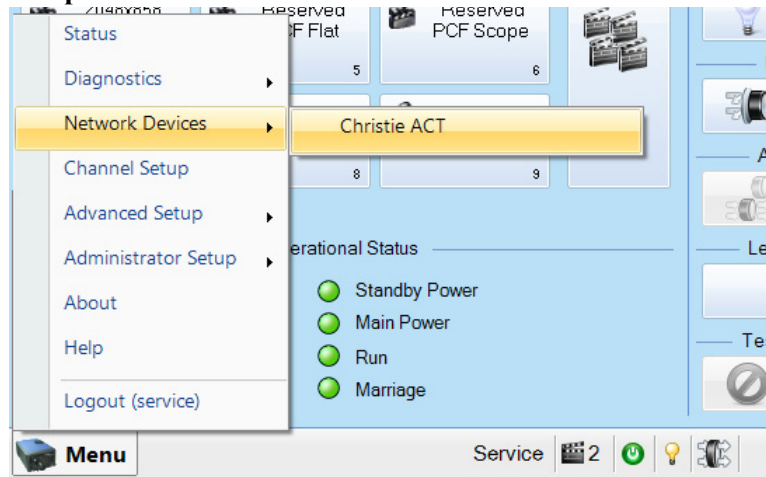


Figure 6-9 Accessing Christie ACT via the Network Devices Window


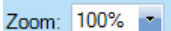
To interact with the device tap  in the top right corner of the window. To alter the zoom of the device, tap,  , in the top right corner of the window.

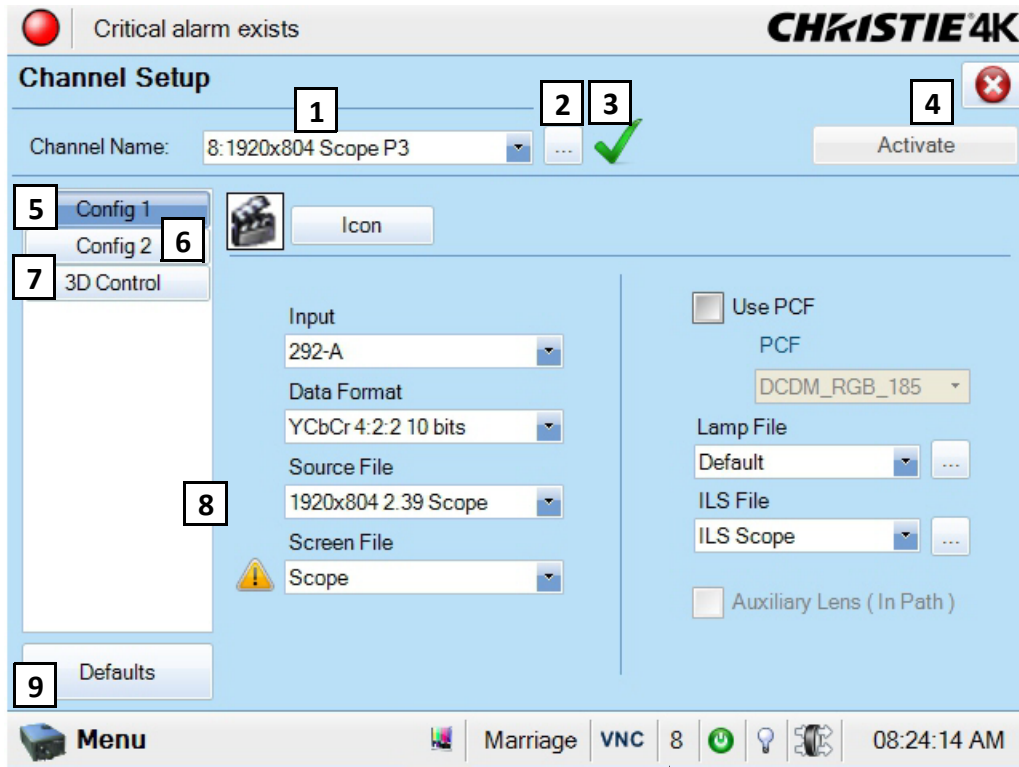


Figure 6-10 Christie ACT Displayed Through the TPC

6.13 Channel Setup Windows

To open the Channel Setup windows you need Advanced, Administrator, or Service permissions. Tap **Menu** > **Channel Setup**.

Use the Channel Setup window to create and store customized projector settings for different inputs. You can create a maximum of 64 channels.



Active Channel

Figure 6-11 Channel Setup Window

Table 6.8 Channel Setup Window

Control	Description
1: Channel Name	The name of the channel.
2: Edit Name	Edits the name of the currently selected channel.
3: Active Channel	Activates the selected channel.
4: Activate	Tapping the Activate button activates the currently selected channel. If the Activate button is disabled, the current channel selected is the active channel.
5: Config 1	General configuration options.
6: Config 2	Color configuration options.
7: 3D Control	Features to support 3D displays.
8: Warning	The currently displayed file does not exist on the system and needs to be defined in the Advanced Setup window.
9: Defaults	Applies the factory default settings of the current channel or all channels.

6.13.1 Config 1 Window

Use the Config 1 window to change the channel configuration settings.

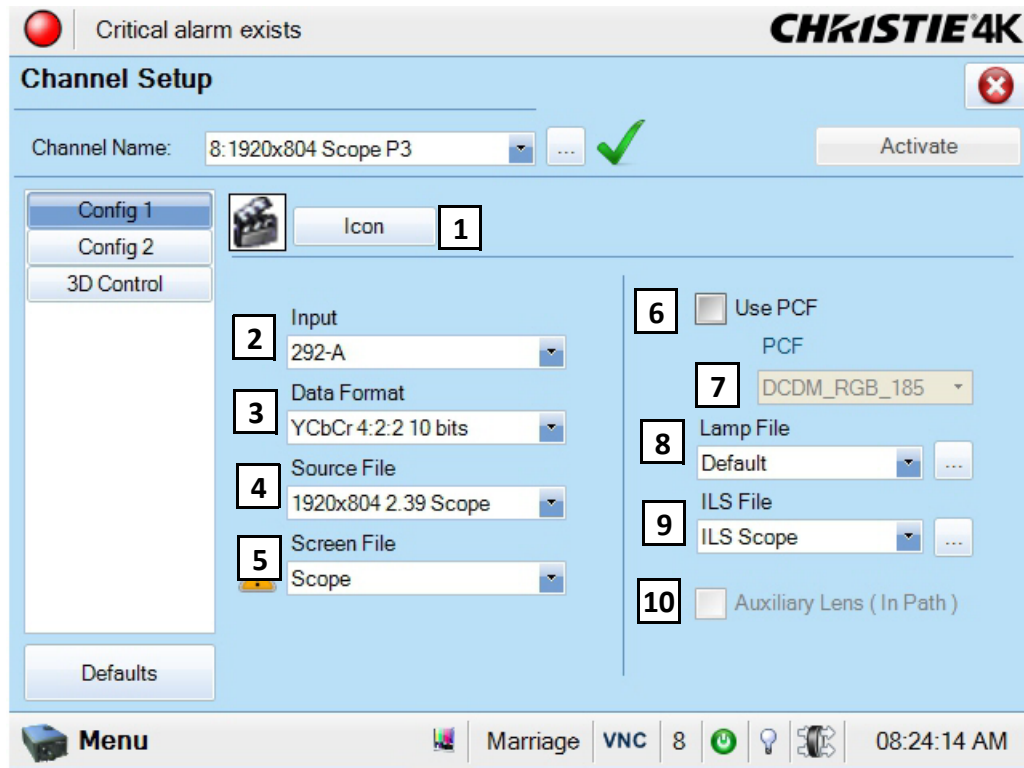


Figure 6-12 Channel Setup: Config 1 Window

Control	Description
1: Icon	The icon associated with the channel.
2: Input	The location or connection for the current input.
3: Data Format	The source type (8-10-12 bit) and whether or not it is packed.
4: Source File	The resolution and aspect ratio of the incoming source. To view a list of available sources, see 6.14.6 Source File Setup Window, on page 6-31 .
5: Screen File	The display area, masking, cropping and lens for the current input.
6: Use PCF	Selects a pre-defined Projector Configuration File (PCF) for the input and prevents Channel adjustments.
7: PCF	The PCF file.
8: Lamp File	The lamp configuration associated with the channel. Click Launch Dialog to edit the lamp file settings. Any changes made to the Lamp File settings are applied to all channels that use this lamp file.
9: ILS File	The ILS configuration associated with the channel. Click Launch Dialog to edit the ILS file settings. Any changes made to the ILS File settings are applied to all channels that use this ILS file.
10: Auxiliary Lens	Indicates if the channel uses an anamorphic lens.

6.13.2 Config 2 Window

Use the Config 2 window to change the color settings of a channel.

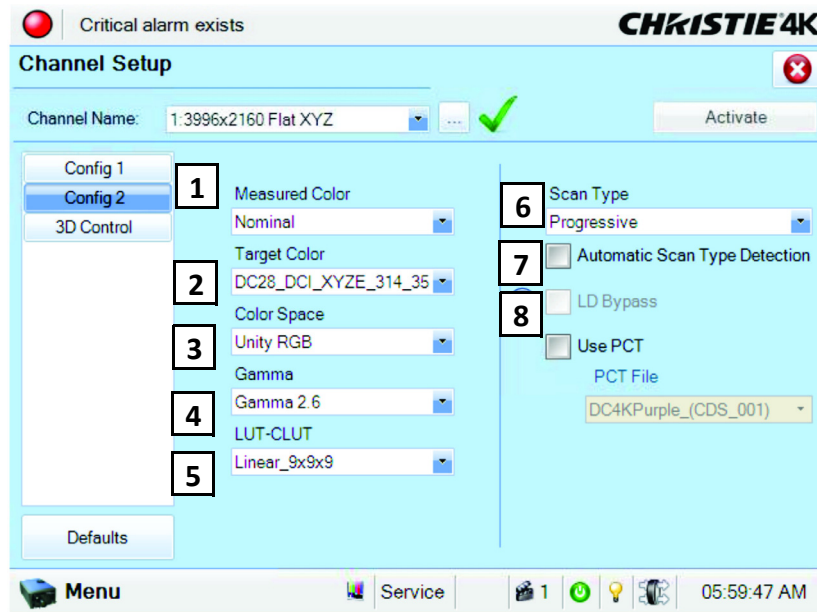


Figure 6-13 Channel Setup: Config 2 Window

Table 6.9 Channel Setup: Config 2 Window

Control	Description
1: Measured Color	The Measured Color Gamut Data (MCGD) file to use as a reference for calculating target color processing.
2: Target Color*	The Target Color Gamut Data (TCGD) value.
3: Color Space*	The method of color decoding for the current source. The default is YCbCr for all DVI sources. The default for all cinema sources is Unity RGB.
4: Gamma*	The gamma correction required for the proper tonal range of the source material.
5: LUT_CLUT*	Applies a 3D color cube for increased color accuracy.
6: Scan Type	The video scan type. The default is Progressive .
7: Automatic Scan Type Detection	Automatically performs scan type detection. This feature is supported for PIB inputs only.
8: LD Bypass	Bypasses the link decrypter. Select this option only if Marriage is broken and the content being displayed is not CineLink 2 encrypted.
6: Pull Down Sequence	Applies the pull down sequence, which is typically a 2:2 Pull Down sequence. Pull down is used to distribute film content to video. Since film is projected at 24 frames per second and video typically at 60 pictures per second, the film content must be converted to video for optimal display.
7: Pull Down Offset	Identifies and sets the frame offset from fields 1 to 5.
8: SMPTE Field Bit	Sets the field offset polarity.
9: Re-Sync	This command is used to enable or disable the re-synchronization function associated with the Pull-Down Sequence.

*** NOTE:** Components marked with an asterisk (*) are part of pre-defined PCFs (Projector Configuration Files) that control image processing for a given source. When you select **Use PCF**, these options are not available.

6.13.3 3D Control Window

Use the 3D Control window to adjust and synchronize incoming 3D signals with external 3D equipment such as screens, emitters, and glasses. For more information, see [4.14 Working with 3D](#).

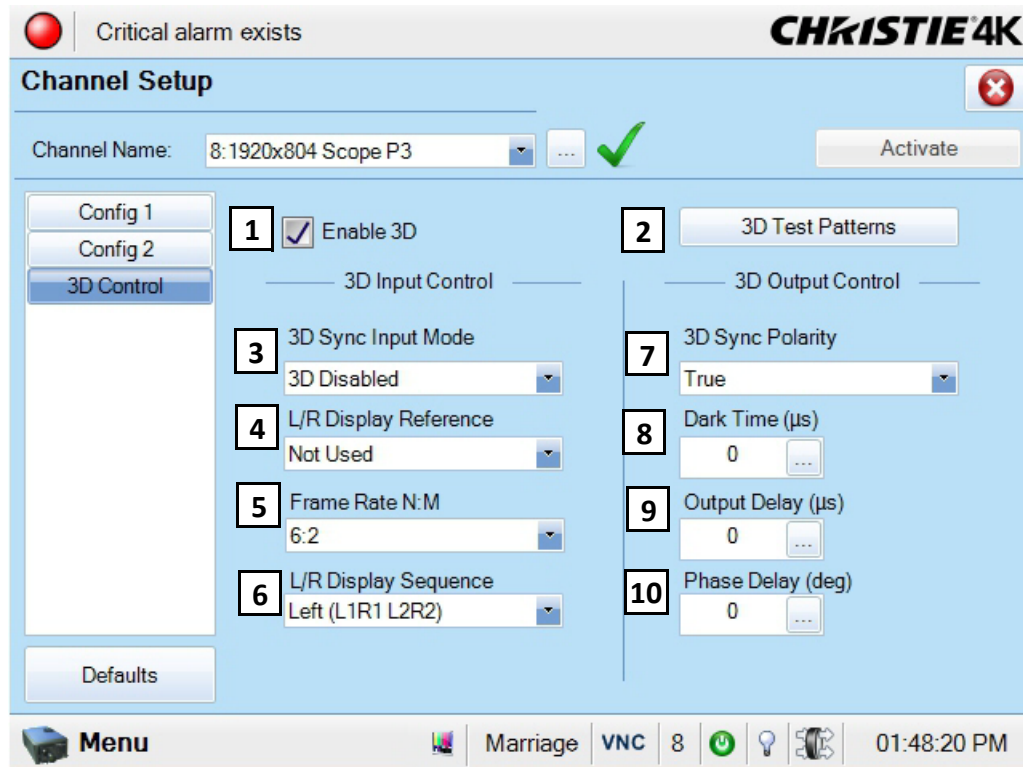


Figure 6-14 Channel Setup: 3D Control Window

Table 6.10 Channel Setup: 3D Control Window

Control	Description
1: Enable 3D	Enables 3D.
2: 3D Test Patterns	Displays 3D test patterns.

Control	Description
3: 3D Sync Input Mode	<p>Specifies whether a specific frame of input data has left eye or right eye data.</p> <p>Use GPI (polarity = true) or (polarity = inverted): Select if you are using a single 3D signal requiring a separate 3D stereo sync input at the GPIO.</p> <p>Use Selected Input Port (polarity = true) or (polarity = inverted): Select if your 3D source provides separate left and right data via 2 cables at the HD-SDI A and HD-SDI B SMPTE ports. This assumes the 3D stereo sync signal is included with the image data inputs rather than supplied separately at the GPIO port.</p> <p>Use White Line Code (true and inverted): Select only if using a single 3D input signal in which an embedded white line at the bottom of each frame identifies left vs. right, and an additional separate 3D stereo sync input at the GPIO port is not present. The bottom row of the left-eye sub-field should be pure white for the left-most 25% of the pixel row and pure black for the remainder of the row. The bottom row of the right-eye sub-field should be pure white for the left-most 75% of the pixel row and pure black for the remainder of the row.</p> <p>Use Line Interleave: For use with 3D source data only. When specified, the TI system will de-interleave each line into the left image or right image in memory as specified. Line interleave can be used with PsF 3D data (left and right data for one field, then left and right data for second field).</p>
4: L/R Display Reference	Specifies which frame of eye data to display during a specific display frame. This signal is referenced to the display frame rate which is specified by the Frame Rate N:M.
5: Frame Rate N:M	Sets how many frames to display per number of frames that form one complete image. Increase the display frame rate to reduce flicker from your source(s).
6: L/R Display Sequence	Defines the frame order (L-R or R-L) required for 3D perspective. This option only has meaning when the Frame Rate factor M is equal to 2. For this case, 2 input frames of data are required to constitute a complete frame of image data. This parameter tells the system which frames go together to make a complete image. NOTE: <i>When using Line Interleave as the 3D Sync Input Mode, ensure that Left (L1R1 L2R2) is selected.</i>
7: 3D Sync Polarity	<p>Keeps 3D stereo sync output the same as input (true) or reversed (inverted).</p> <p>True: 3D L/R sync output from GPO will match L/R sync input.</p> <p>Inverted: 3D L/R sync output from GPO will be the opposite of sync input (left = right, right = left).</p>
8: Dark Time	Creates a blank time interval between left and right frames to allow for LCD shutter glasses, Z screen, or rotating 3D wheel to synchronize the output. See <i>Dark Time and Output Delay Notes</i> below. Values between 0 and 65535 are accepted. Tap the Launch Dialog button to enter the dark time value.
9: Output Delay	The non-image time in Microseconds (μ). Offset 3D stereo sync output in relation to dark time interval. Acceptable values are between -32768 and 32767 are accepted where a positive offset = delay and negative offset = start early. Tap Launch Dialog to enter the output delay value.
10: Phase Delay	The degree of reference between the left and right sync output. Values between -180 and 180 are accepted. Tap Launch Dialog to enter the phase delay value.

FRAME RATE N:M NOTES

These N:M ratios define how many frames to display per number of frames that form one complete image. For all 3D use, the denominator is 2, indicating that 2 frames (left and right) are combined into every complete display frame. For non-3D, it is 1 frame. Set it to the highest rate possible without image cropping.

EXAMPLE

4:2 = 4 frames displayed 2 frames per image
--

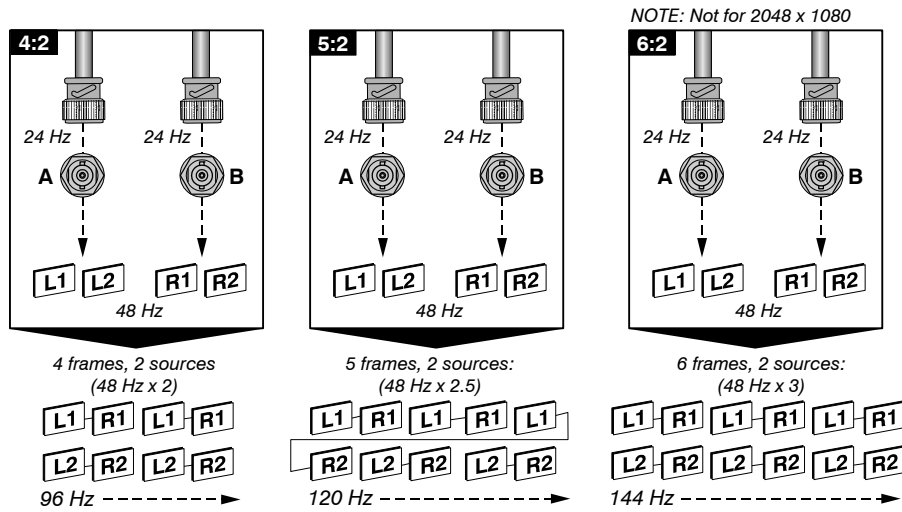


Figure 6-15 Examples of Frame Rate N:M

DARK TIME and OUTPUT DELAY NOTES

The dark time between incoming left and right frames provides a brief interval of non-image time (in microseconds) for your switching device (such as shutters in glasses) to complete its switch. When this interval is set properly, neither eye sees image data intended for the other eye and this helps to prevent color artifacts and ghosting. The output delay setting shifts the 3D sync in relation to the Dark Time interval, starting each frame slightly earlier (-) or later (+). Too much offset can cause “bleed-through” where each eye sees some data that is intended for the other, or causes color cropping since some DMD sequences may be clipped.

6.14 Advanced Setup Windows

To open the Advanced Setup window you need Advanced, Administrator, or Service permissions.

Use the Advanced Setup windows to define the operating parameters for the projector including lamp settings and the lens position.

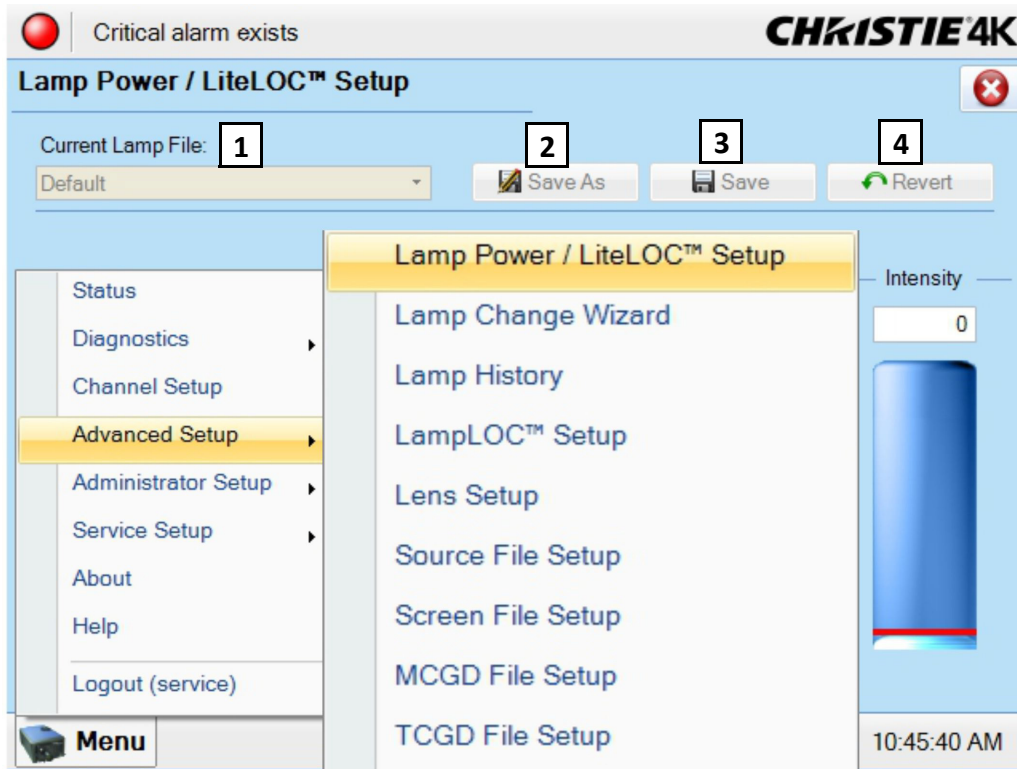


Figure 6-16 Functionality in Advanced Setup Windows

Table 6.11 Functionality in Advanced Setup Windows

Control	Description
1: Current File	The file to which you want to apply modifications. This option is only available in the Lamp Power / LiteLOC™ Setup , ILS Setup , Source File Setup , Screen File Setup , MCGD File Setup and TCGD File Setup windows. Changes are applied to all channels that use this file.
2: Save As	Saves the configuration file with a new name.
3: Save	Saves the configuration file.
4: Revert	Cancels unsaved screen settings and reapplies the saved settings.

6.14.1 Lamp Power / LiteLOC™ Setup Window

LiteLOC™ is a power control algorithm that increases the power level to maintain lamp brightness as the lamp ages. Tap **Menu** > **Advanced Setup** > **Lamp Power/LiteLOC™ Setup**.

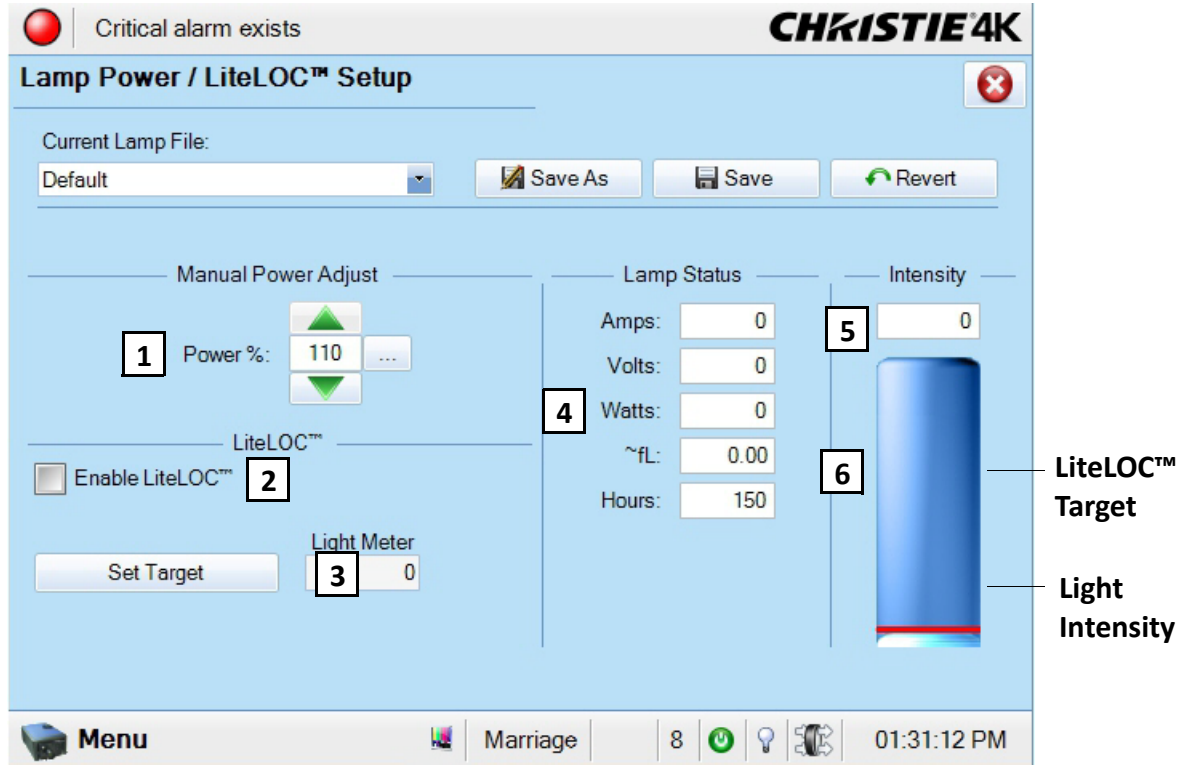


Figure 6-17 Advanced Setup: Lamp Power / LiteLOC™ Setup Window

Table 6.12 Advanced Setup: Lamp Power / LiteLOC™ Setup

Control	Description
1: Power %	The percentage of power to supply to the lamp. See 6.14.2 for the valid Lamp Power ranges for specific lamp types.
2: Enable LiteLOC™	Applies LiteLOC™ to the current channel.
3: Light Meter - Set Target	Automatically enables LiteLOC™ and maintains the current brightness level as long as possible. The Light Meter value is an arbitrary unit of measure, not lumens or fL.
4: Amps, Volts, Watts, ~FL or ~cd/m ² , Hours	Lamp current in amperes, lamp voltage in volts, lamp power in watts, approximate Foot Lamberts reading on the light sensor (assuming a calibration was performed), and hours on current lamp.
5: Text Region	The current light sensor reading in arbitrary units-of -measure and does not represent actual lumens or fL.
6: Light Bar	The current light intensity and LiteLOC™ target.

6.14.2 Lamp History Window

The **Lamp History** window displays a list of the previous and current lamps installed in the projector. Tap **Menu > Advanced Setup > Lamp History**.

You cannot remove a lamp from the list after you add it.

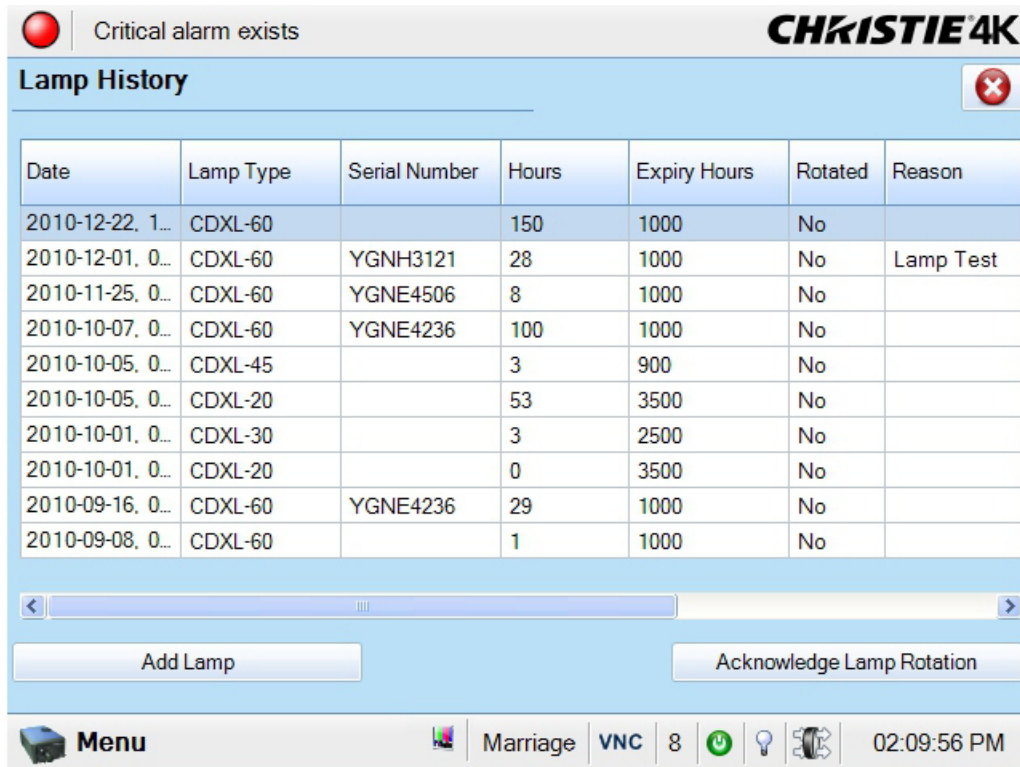


Figure 6-18 Advanced Setup: Lamp History Window

Table 6.13 Advanced Setup: Lamp History Window

Control	Description
Date	The date the lamp was installed.
Lamp Type	The lamp type.
Serial Number	The lamp serial number.
Hours	The number of hours the lamp has operated.
Expiry Hours	The number of hours the lamp operates before it is replaced.
Rotated	Specifies if the lamp has been rotated.
Reason	The reason for changing the lamp.
Add Lamp	Tap Add Lamp to open the Add Lamp window. See Add Lamp Window, on page 6-27 .
Acknowledge Lamp Rotation	Acknowledge the lamp has been rotated.

Add Lamp Window

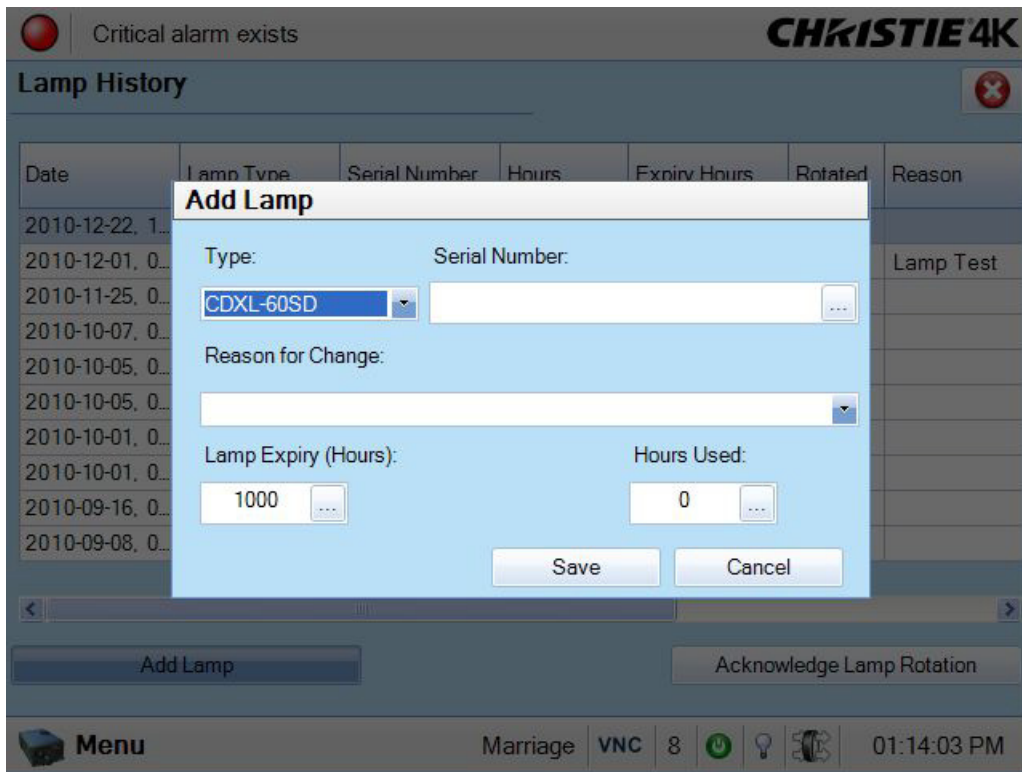


Figure 6-19 Advanced Setup: Add Lamp Window

Table 6.14 Advanced Setup: Add Lamp Window

Control	Description
Type	The lamp type.
Serial Number	The serial number of the new lamp. A serial number can be up to 32 alpha-numeric characters.
Reason for Change	The reason you are installing the lamp.
Lamp Expiry	The number of hours the lamp operates before it is replaced. For information about lamp expiry hours for available lamps, see 5.5.10 Lamp Expiry Hours.
Hours Used	The number of hours the lamp has operated.

6.14.3 LampLOC™ Setup Window

Use the LampLOC Setup window to reposition the projector bulb for optimized light output. Tap **Menu** > **Advanced Setup** > **LampLOC™ Setup**

Click **Do Auto** to run LampLOC automatically. You must turn the lamp on before you run LampLOC. If you turn the lamp off during LampLOC, the bulb returns to its former position. The douser is open and it is not functional during a LampLOC adjustment. To keep the bulb optimized as it ages, run LampLOC once a month.

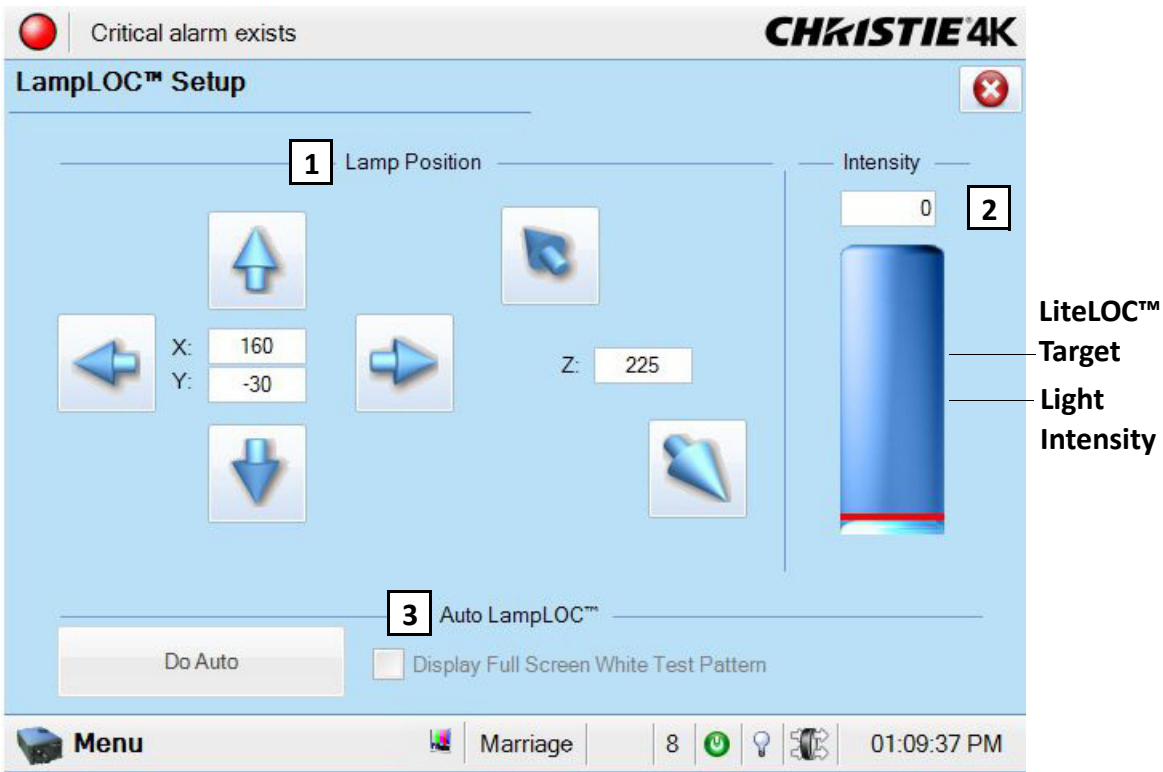


Figure 6-20 Advanced Setup: LampLOC™ Setup Window

Table 6.15 Advanced Setup: LampLOC™ Setup Window

Control	Description
Left/Right Up/Down In/Out Arrow Buttons	Moves the lamp up, down, in, out, left, and right. The current position of the lamp displays in Cartesian coordinates. Tap once to increase or decrease the lamp position by a single increment. Press and hold a button to increase or decrease the lamp position by multiple increments. You cannot move the lamp beyond the pre-defined limits for the projector. For CP2210, X/Y = +/-250; Z = +/-175.
Value	Shows the current light sensor reading in arbitrary units-of -measure and does not represent actual lumens or fL.
Light Bar	Indicates the current light intensity (vertical bar) and LiteLOC™ target (red horizontal line).
Do Auto	Starts the auto LampLOC™ calibration procedure, which adjusts the lamp position until the highest light reading is obtained from the light sensor.
Display Full Screen White Test Pattern	Temporarily displays a full screen white test pattern for the duration of the LampLOC™ adjustment. The previous display reappears when you close the LampLOC™ Setup page or clear the check box.
Auto LampLOC™ Progress Bar	Shows the current LampLOC™ procedure completion status.
Cancel Auto	Cancels the LampLOC calibration.

6.14.4 ILS File Setup Window

⚠ WARNING To prevent the projection lens and the Motorized Auxiliary Lens Mount (MALM) colliding, move the MALM to the out position before calibrating the lens or resetting the MALM. When performing a lens calibration keep your fingers away from moving parts.

Use the ILS File Setup window to modify the Intelligent Lens System (ILS) settings in an ILS file. Tap **Menu > Advanced Setup > ILS File Setup**

The ILS File Setup window is not available if you have not selected the ILS Installed option in the Lens Setup window. Changes made to settings are applied to all channels that use the ILS file. Tap once to increase or decrease the focus, offset, or zoom by a single increment. Press and hold a button to increase or decrease the focus, offset, or zoom by multiple increments. If you adjust the focus, offset, or zoom of the lens mount manually, the new settings are not saved in the ILS file.

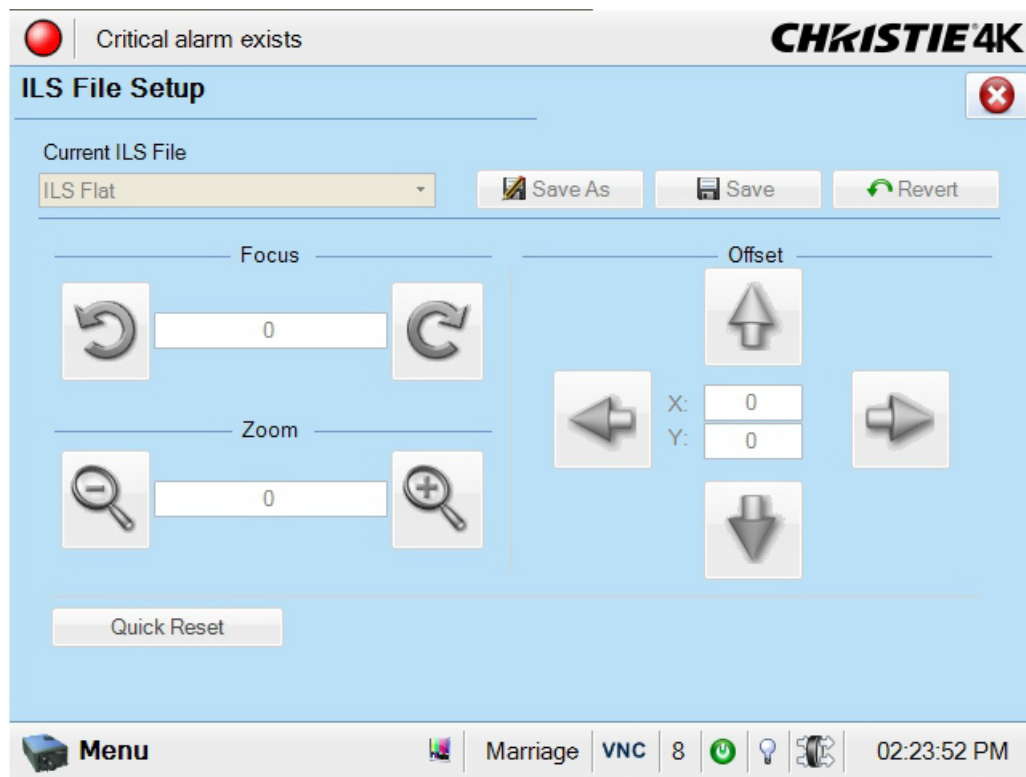


Figure 6-21 ILS File Setup Window

Table 6.16 ILS File Setup Window

Control	
Focus	Adjusts the zoom.
Zoom	Adjusts the offset.
Offset	Resets the lens to the mechanical center before moving back to the original position.
Quick Reset	Resets the position of the MALM to the mechanical reference point.

6.14.5 Lens Setup Window

Use the Lens Setup window to setup the primary and auxiliary lenses and configure the Intelligent Lens System (ILS) if it is installed. Tap **Menu > Advanced Setup > Lamp Power/LiteLOC™ Setup**.

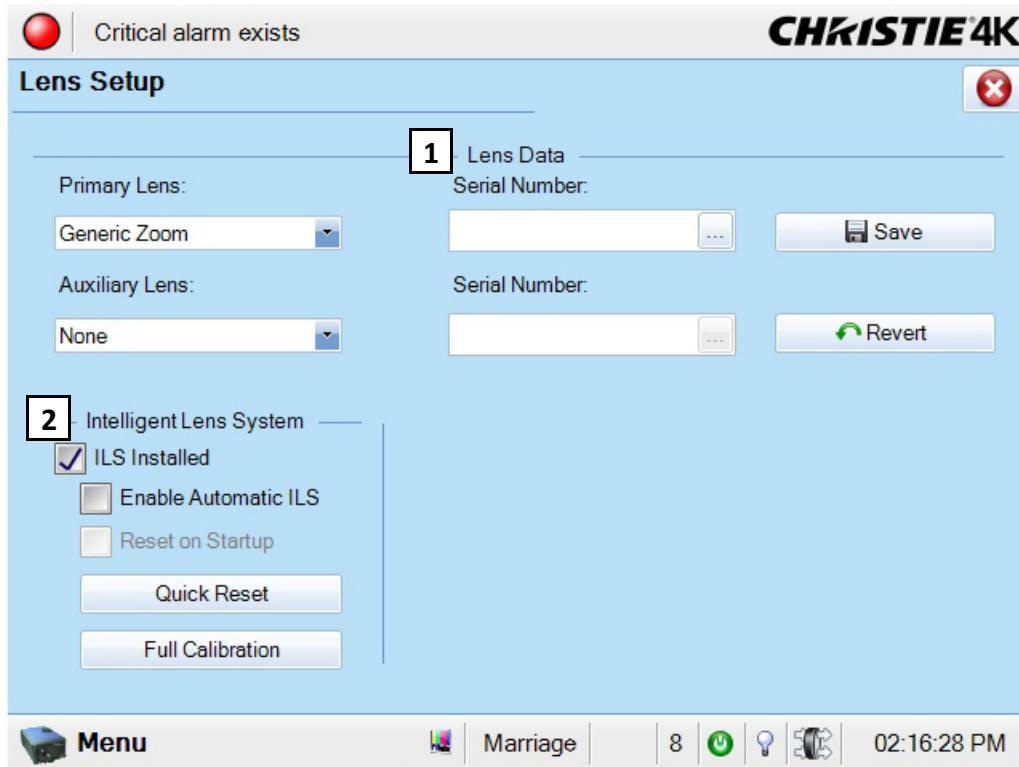


Figure 6-22 Advanced Setup: Lens Setup Window

Table 6.17 Advanced Setup: Lens Setup Window

Control	Description
Primary Lens	The type of primary lens installed on the projector.
Serial Number	The serial number for the primary lens.
Auxiliary Lens	The type of auxiliary lens installed on the projector.
Serial Number	The serial number for the auxiliary lens.
Save	Saves the lens type or serial number(s).
Revert	Reverts to the last saved values for the lens type or serial number(s).
Enable Automatic ILS	Automatically moves the lens to the position specified by the channel and overwrites focus, zoom, and offset settings in the ILS file.
Reset on Startup	Uses ILS settings to calibrate the lens when you start the projector.
Quick Reset	Resets the ILS and returns the lens to the manual position..
Full Calibration	Perform a full ILS calibration and returns the lens to the manual position.
MALM Installed	Indicates a MALM is installed on the projector.
MALM Reset	Resets the position of the MALM to the mechanical reference point.

Control	Description
In	Moves the MALM to the right or left. If the MALM is in the OUT position (right), the MALM moves to the IN position (left) before the incremental adjustments begin.
Out	Moves the MALM to the right or left. If the MALM is in the IN position, the MALM moves to the OUT position (right) before the incremental adjustments begin.

6.14.6 Source File Setup Window

Use the Source File Setup window to create source files that store resolution, offset, and aspect ratio settings for input devices. Tap **Menu** > **Advanced Setup** > **Source File Setup**.

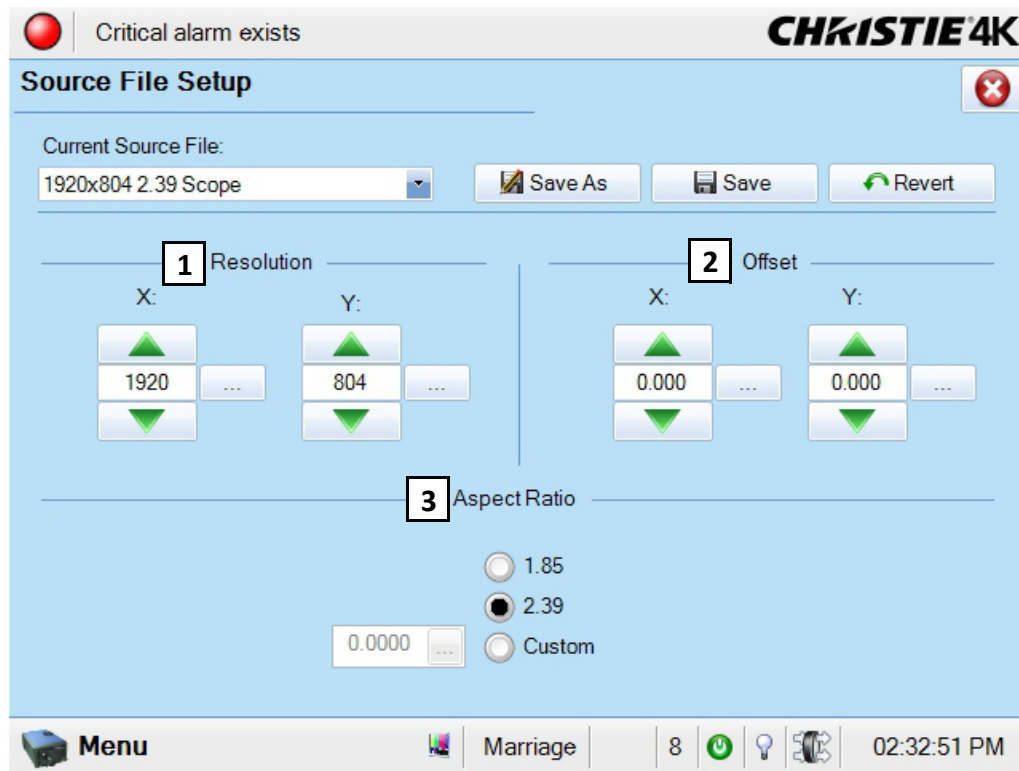


Figure 6-23 Advanced Setup: Source File Setup Window

Table 6.18 Advanced Setup: Source File Setup Window

Control	Description
1: Resolution	The X and Y resolution of the incoming signal. For example, 2048 (X) and 858 (Y) or 1920 (X) and 1080 (Y). The resolution must match the incoming signal format. Tap once to increase or decrease the resolution by a single increment. Tap and hold a button to increase or decrease the resolution by multiple increments.
2: Offset	The amount of incoming data to discard. Set the values to zero to process all incoming data. Tap once to increase or decrease the offset by a single increment. Press and hold a button to increase or decrease the offset by multiple increments. The allowable X range is -4096 to 4096 pixels and Y range of -2160 to 2160 pixels.
3: Aspect Ratio	The aspect ratio for the incoming signal. The allowable range is 0 to 7.99.

6.14.7 Screen File Setup Window

Use the Screen File Setup window to define the display panel size and how you want the image cropped. You can save your settings, and apply them to other input devices. Tap **Menu** > **Advanced Setup** > **Screen File Setup**.

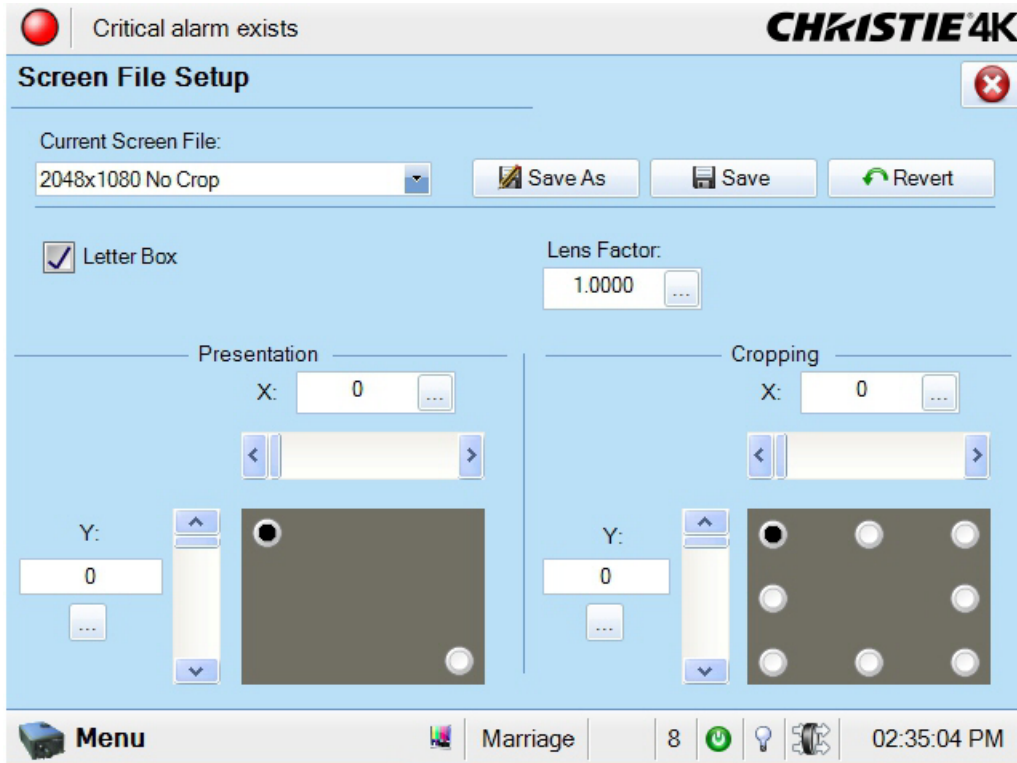


Figure 6-24 Advanced Setup: Screen File Setup Window

Table 6.19 Advanced Setup: Screen File Setup Window

Control	Description
Letter Box	All image data is displayed and the aspect ratio is maintained.
Lens Factor	The amount you want to stretch an image horizontally. Allowable values can range from 0.00 to 7.99. Enter 1 if you are not using an anamorphic lens.
Presentation	The size and location of the image. By default, the projector uses a 4096 x 2160 panel.
Cropping	Hides unwanted image data.

6.14.8 MCGD File Setup Window

Use the MCGD File Setup window to correct uncorrected, on-screen colors. Tap **Menu** > **Advanced Setup** > **MCGD File Setup**.

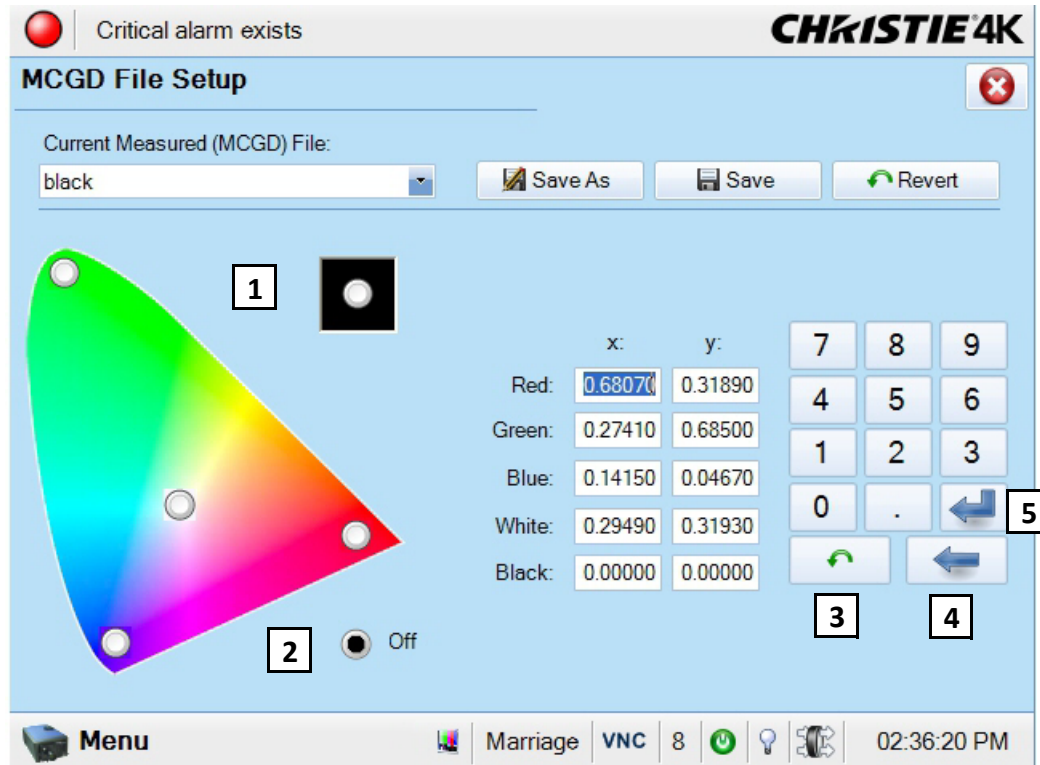


Figure 6-25 Advanced Setup: MCGD File Setup Window

Table 6.20 Advanced Setup: MCGD File Setup Window

Control	Description
1: Gamut Visual Control	Enables the color test pattern on the screen.
2: Off Button	Turns off the displayed color and returns the projector to content play.
3: Revert	Reverts to the previously saved value.
4: Back	Deletes the entry before the cursor one character at a time.
5: Enter Button	Advances the cursor to the next text region.

Record MCGD Color Settings

1. On the Touch Pad Controller, tap **Menu** > **Advanced Setup** > **MCGD File Setup**.
2. In the **Current Measured (MCGD) File** list, select **Onsite**.
3. Tap a color option button to display the full-field YCbCr test pattern.
4. Measure the coordinates at the screen with a color meter.
5. Enter the values in the **X** and **Y** fields of the **MCGD File Setup** window.
6. Repeat Steps 3 - 5 for each color.
7. Select **Off** and then tap **Save**.

6.14.9 TCGD File Setup Window

Use the TCGD File Setup window to modify or create custom Target Color Gamut Data (TCGD) files. Tap **Menu > Advanced Setup > TCGD File Setup**.

A TCGD file appears in the **Channel Setup: Config 2** window as **Target Color** where you can select it for use in the display.

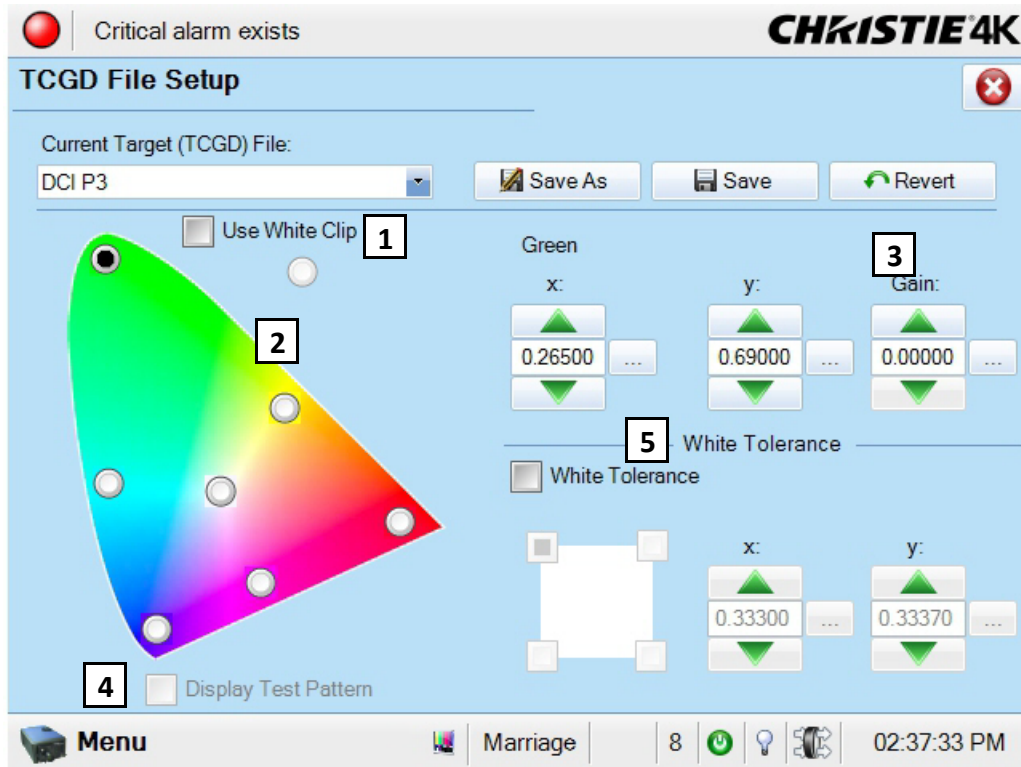


Figure 6-26 Advanced Setup: TCGD File Setup Window

Table 6.21 Advanced Setup: TCGD File Setup Window

Control	Description
1: Use White Clip *	Brings the chromaticity of white within range with the projector without sacrificing output brightness or contrast.
2: Gamut Visual Control *	Displays the corresponding x and y color coordinates for the current target color gamut.
3: Gain *	The brightness or intensity of each color when compared with a full white, ranging from 0 (0%) to 1 (100%).
4: Display Test Pattern	Shows a test pattern when the color changes.
5: White Tolerance *	Enables the White Tolerance grid and x and y text boxes.

6.15 Administrator Setup Windows

To open the Administrator Setup window you need Administrator, or Service permissions. Use the Administrator Setup windows to define projector settings.

6.15.1 System Access Window

The **System Access** window provides access to the Windows operating system of the TPC.

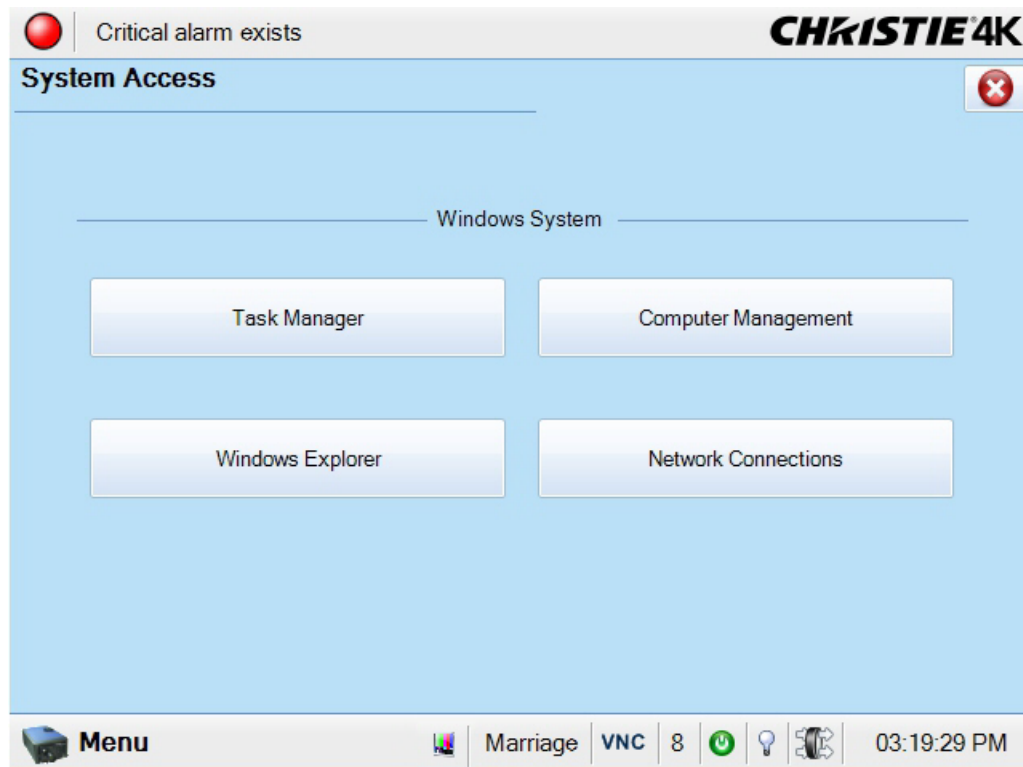


Figure 6-27 Administrator Setup: System Access Window

Control	Description
Task Manager	Tap the Task Manager button to launch the system task manager.
Computer Management	Tap the Computer Management button to launch the system's computer management window.
Windows Explorer	Tap the Windows Explorer button to launch Windows Explorer.
Network Connections	Tap the Network Connections button to interact with the system's network connections.

6.15.2 Preferred Channel Setup Window

To open the Preferred Channel Setup window you need Administrator or Service permissions. Tap **Menu** > **Administrator Setup** > **Preferred Channel Setup**.

Use the Preferred Channel Setup window to manage and organize the channels that appear on the Main panel of the Touch Panel Controller.

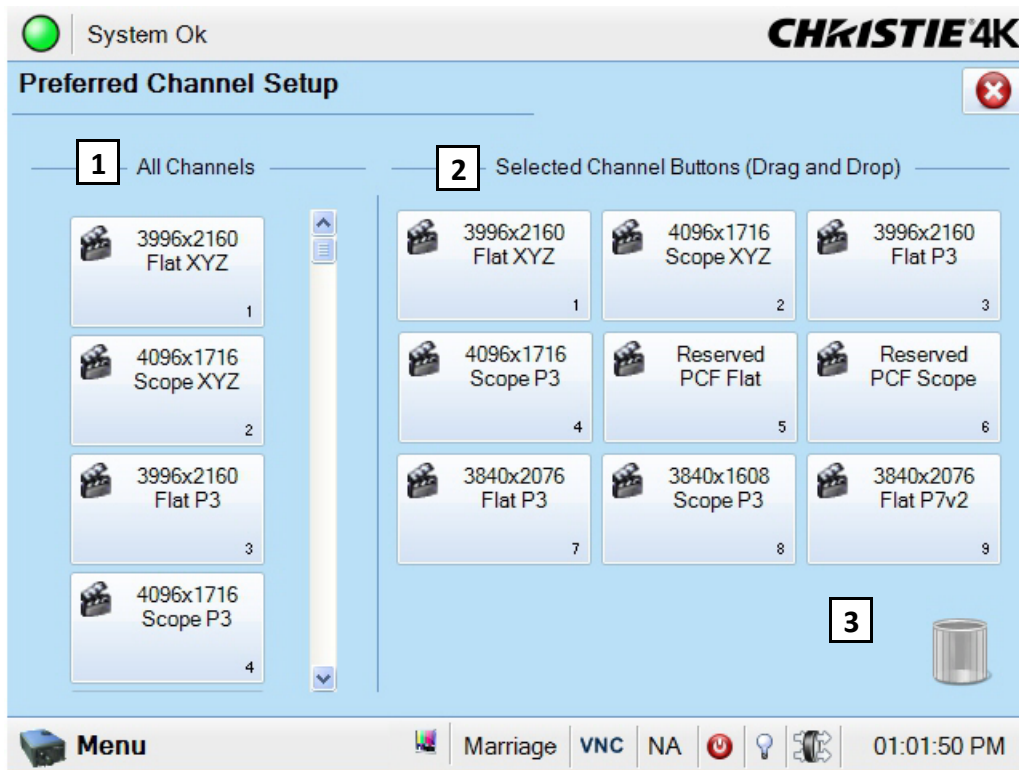


Figure 6-28 Administrator Setup: Preferred Channel Setup Window

Table 6.22 Administrator Setup: Preferred Channel Selection Window

Control	Description
1: All Channels	An alphabetical list of the 64 available channels.
2: Selected Channel Buttons	The 9 buttons that display on the Main panel of the TPC.
3: Trash Can	Deletes a channel from the Selected Channel Buttons area.

6.15.3 Preferred Test Pattern Setup Window

Use the Preferred Test Pattern Setup window to manage and organize test patterns. To open the Preferred Test Pattern Setup window you need Administrator or Service permissions. Tap **Menu > Administrator Setup > Preferred Test Pattern Setup**.

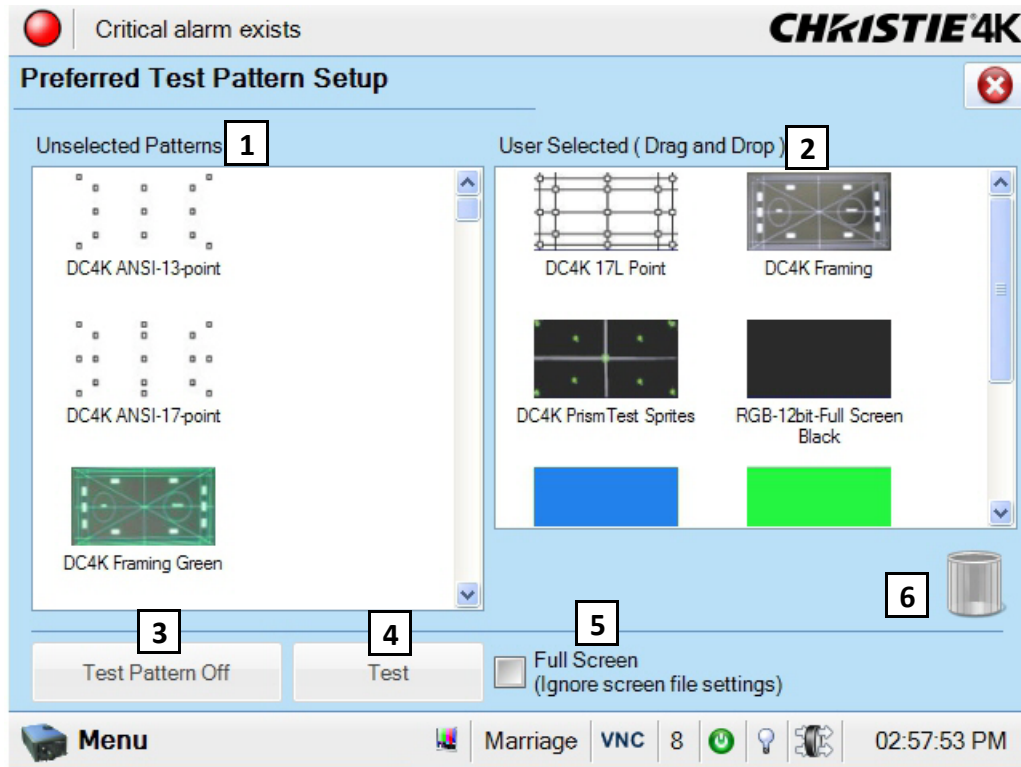


Figure 6-29 Administrator Setup: Preferred Test Pattern Setup Window

Table 6.23 Administrator Setup: Preferred Test Pattern Setup Window

Control	Description
1: Unselected Patterns	An alphabetical list of all available test patterns for display by the projector for you to choose from. If a pattern is dragged to the User Selected region, it will be removed from this list.
2: User Selected	A list of test patterns selected by you.
3: Test Pattern Off	Removes the test pattern currently displayed.
4: Test	Displays the selected test pattern.
5: Full Screen	Displays the test pattern full screen, 2048 x 1080.
6: Trash Can	Used to delete a test pattern from the User Selected region.

6.15.4 Preferences Window

Use the Preferences window to modify projector system settings. To open the Preferences window you need Administrator or Service permissions. Tap **Menu** > **Administrator Setup** > **Preferences**.

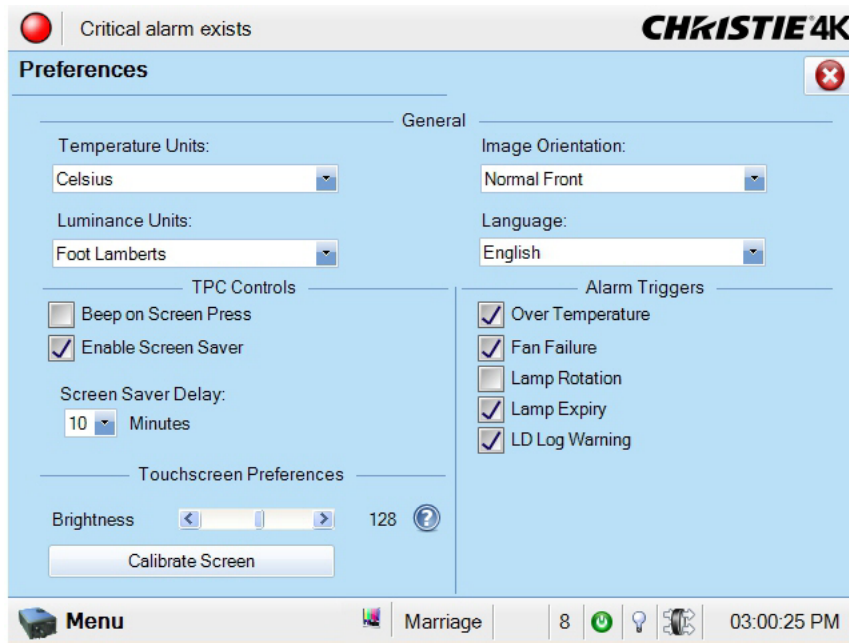


Figure 6-30 Administrator Setup: Preferences Window

Table 6.24 Administrator Setup: Preferences Window

Control	Description
Temperature Units	Determines if temperature information is displayed in Celsius or Fahrenheit.
Image Orientation	The direction of the on screen image.
Luminance Units	Determines if luminance information is displayed in Foot Lamberts or Candela.
Language	The language for the TPC and online help.
Beep on Screen Press	Plays a sound when you touch the TPC screen.
Enable Screen Saver / Screen Saver Delay	Enables a screen saver and determines the frequency that the screen saver appears.
Over Temperature, Fan Failure, Lamp Rotation, Lamp Expiry, LD Log Warning	Opens an alarm window when a pre-defined event occurs.
Brightness	Adjusts the brightness of the touch screen display.
Calibrate Screen	Opens the Calibrate window.

6.15.5 Content Devices Configuration Window

Use the Content Devices Configuration window to indicate when a Link Decrypter (LD) or an Image Media Block (IMB) is installed in the projector. To open the Content Devices Configuration window you need Administrator or Service permissions. Tap **Menu > Administrator Setup > Content Devices Configuration**.

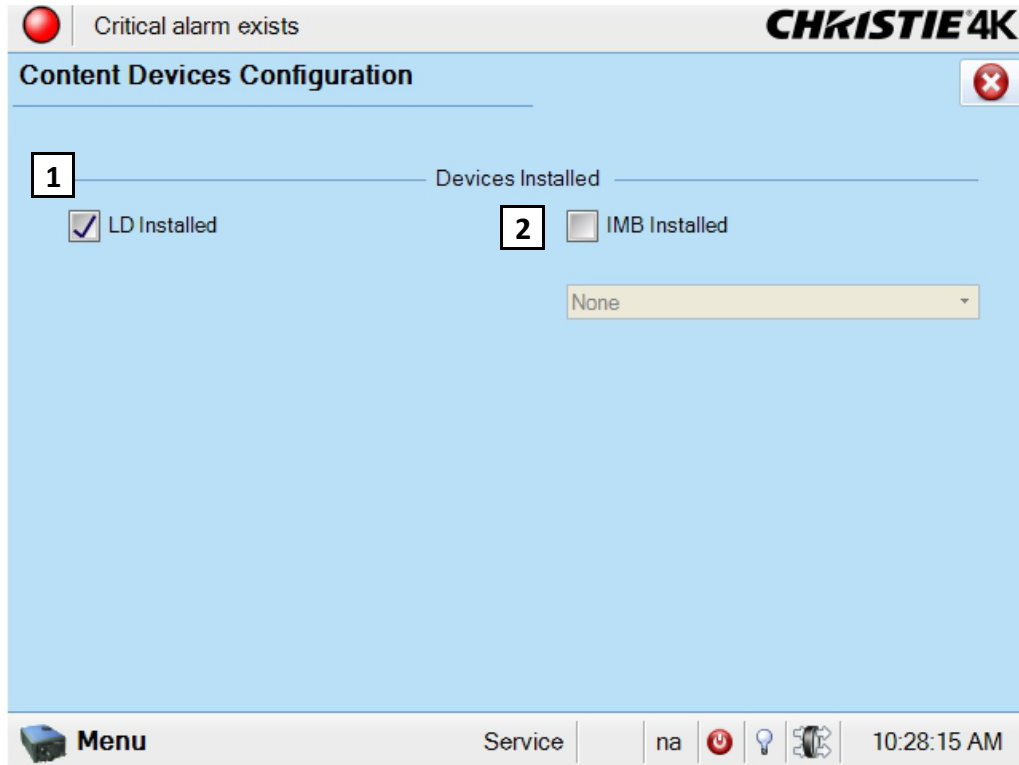


Figure 6-31 Administrator Setup: Content Devices Configuration Window

Table 6.25 Administrator Setup: Content Devices Configuration

Control	Description
LD Installed	Indicates a Link Decrypter (LD) is installed.
IMB Installed	Indicates an Image Media Block (IMB) is installed.

6.15.6 Time Setup Window

Use the Time Setup window to change projector time settings. To open the Time Setup window you need Administrator or Service permissions. Tap **Menu > Administrator Setup > Time Setup**.

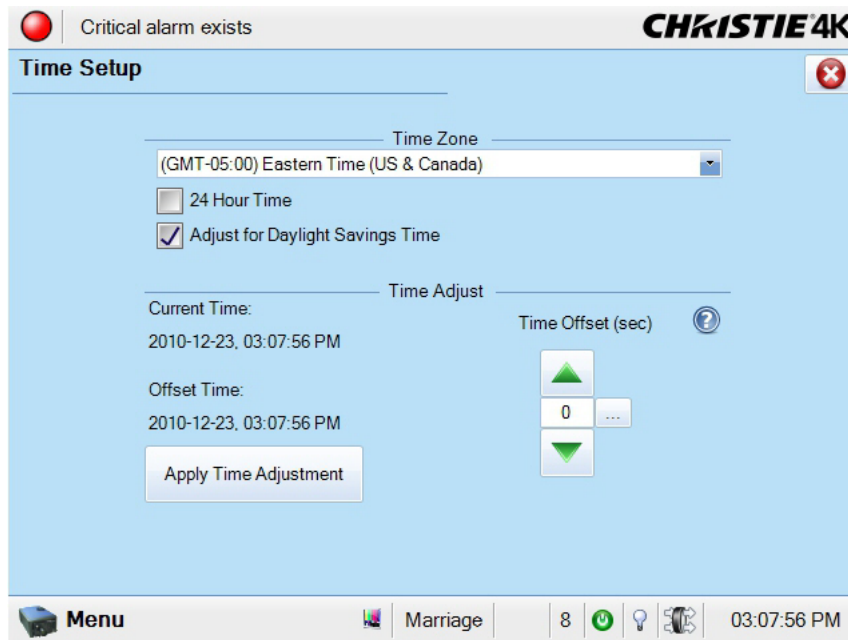


Figure 6-32 Administrator Setup: Time Setup Window

Table 6.26 Administrator Setup: Time Setup Window

Control	Description
Time Zone	The time zone where the projector is installed.
24 Hour Time	Displays time in a 24-hour format.
Adjust for Daylight Savings Time	Automatically adjusts the time for daylight savings.
Time Offset	Increases or decreases the projector time.
Apply Time Adjustment	Applies time adjustment settings.

6.15.7 Scheduler Window

Use the Scheduler window to schedule when the projector turns on or off. To open the Scheduler window you need Administrator or Service permissions. Tap **Menu > Administrator Setup > Scheduler**.

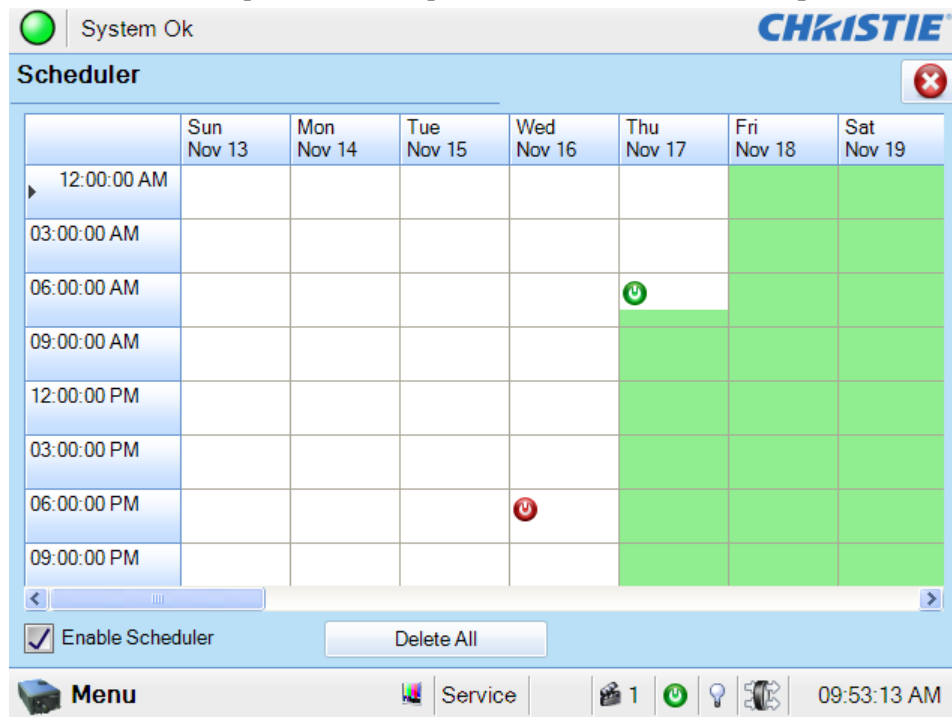


Figure 6-33 Administrator Setup: Scheduler Window

Table 6.27 Administrator Setup: Scheduler Setup Window

Control	Description
Enable Scheduler	Enables or disables the scheduler.
Delete All	Deletes all scheduled events.

6.15.8 Communications Configuration Window

The **Communications Configuration** window configures the Ethernet settings, serial communication parameters, SNMP settings, and remote access settings. **NOTE:** Record any new settings on [page I-1](#) of this manual.

Communications Configuration

Device Name: **1**
Solaria

2 Ethernet Settings
 IP Address: 192 ... 168 ... 231 ... 170 ...
 Subnet Mask: 255 ... 255 ... 252 ... 0 ...
 Gateway: 192 ... 168 ... 228 ... 1 ...
 Apply

3 RS-232 Settings
 Serial Speed (Baud): 115200

4 SNMP Settings
 Enable SNMP SNMP V2 SNMP V3
 Management IP: 0 ... 0 ... 0 ... 0 ...
 Download MIB to USB Apply

5 Remote Access
 Serial Access: Login Required
 Ethernet Access: Login Required

Menu Marriage VNC 8 03:09:12 PM

Figure 6-34 Administrator Setup: Communications Configuration Window

Table 6.28 Administrator Setup: Communications Configuration Window

Control	Description
I: Device Name	The name of the network device.
IP Address	The IP address of the network device.
Subnet Mask	The subnet mask to which the address belongs.
Gateway	The IP address for the network gateway.
Apply	Applies Ethernet settings.
Serial Speed (Baud)	The baud rate of the serial port. The default is 115200.
Enable SNMP	Enables SNMP.
SNMP V2 / SNMP V3	The SNMP protocol type. Contact Christie for the SNMP V3 user ID and password.
Management IP	The IP address where SNMP information and notifications are sent.
Download MIB to USB	Sends the SNMP Management Information Base (MIB) file to a USB drive.
Apply	Applies SNMP settings.
Serial Access	Grants access to serial connections.
Ethernet Access	Grants access to Ethernet connections.

6.15.9 Network Devices Setup Window

Use the Network Devices window to view the web interface of external peripherals such as Christie ACT and the Integrated Media Block (IMB). Tap **Menu > Administrator Setup > Network Devices Setup**.

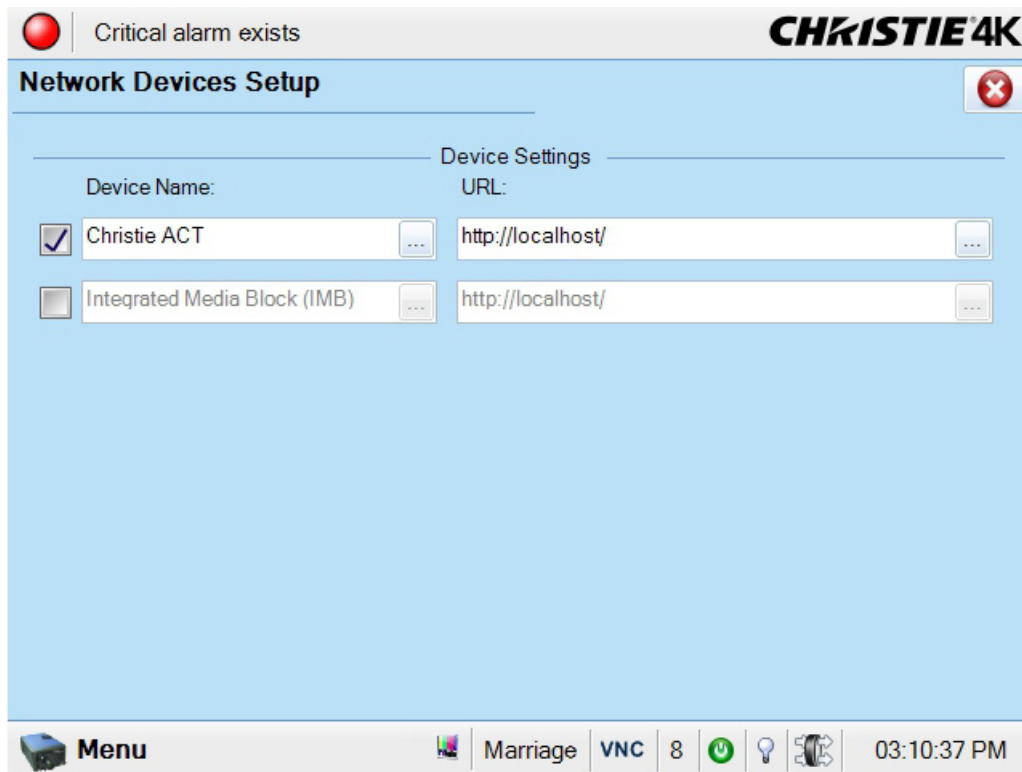


Figure 6-35 Administrator Setup: Network Devices Setup Window

Add a Network Device

1. Tap **Menu > Administrator Setup > Network Devices Setup**
2. In the **Device Name** area, select the check box to the left of the device you are adding.
3. Enter the device name in the **Device Name** field.
4. In the **URL** field, enter the URL of the device you are adding.
5. Click **Menu**, select **Network Device**, and then select a network device. The web interface for this device appears.

6.15.10 GPIO Setup Window

Use the GPIO Setup window to configure the input and output settings of the GPIO interface. To open the GPIO Setup window you need Administrator or Service permissions. Tap **Menu > Administrator Setup > GPIO Setup**.

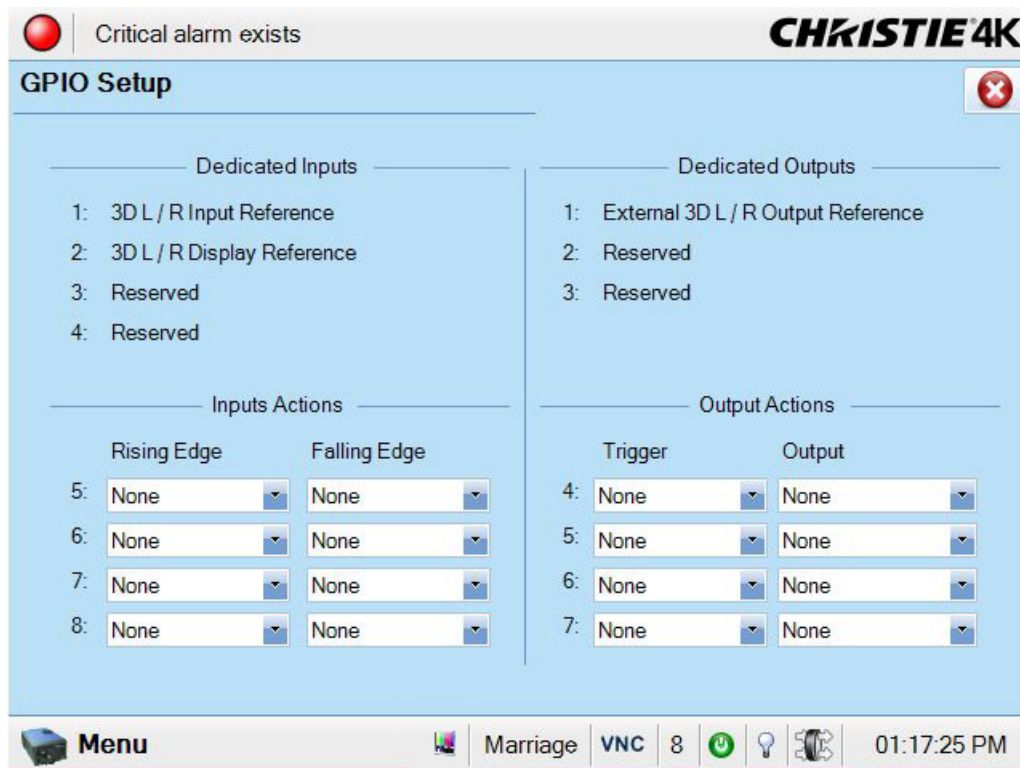


Figure 6-36 Administrator Setup: GPIO Setup Window

Table 6.29 Administrator Setup: GPIO Setup Window

Control	Description
Rising Edge	The rising edge for the signal.
Falling Edge	The falling edge for the signal.
Trigger	The trigger that is sent when the function is activated.
Output	The output that triggers the GPIO signal.

6.15.11 Foot Lamberts Calibration Window

Use the Foot Lamberts Calibration wizard to calibrate the internal light meter to Foot Lamberts. When you run Foot Lamberts Calibration during a show, the show stops. To run the Foot Lamberts Calibration wizard you need Administrator or Service permissions. Tap **Menu > Administrator Setup > Foot Lamberts Calibration**.

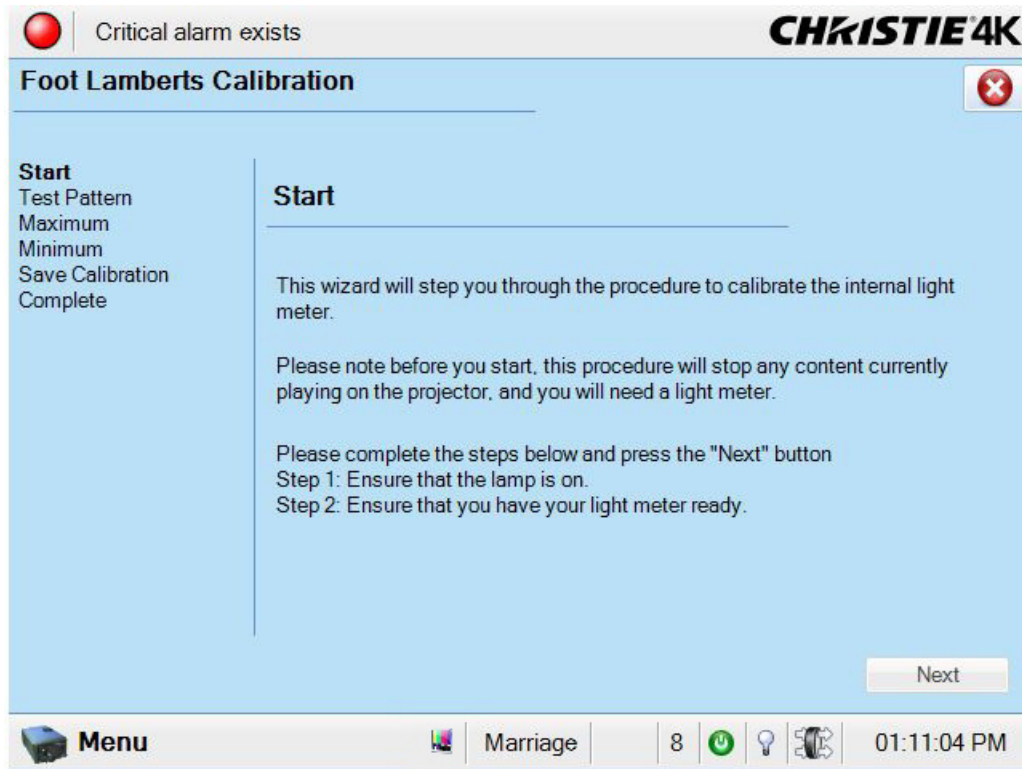


Figure 6-37 Administrator Setup: Foot Lamberts Calibration Start Window

6.15.12 User Accounts Window

Use the **User Accounts** window to manage users, passwords, and user access rights. Depending on your login level, you will be able to manage users having the same or fewer access rights as you. Tap **Menu > Administrator Setup > User Accounts**.

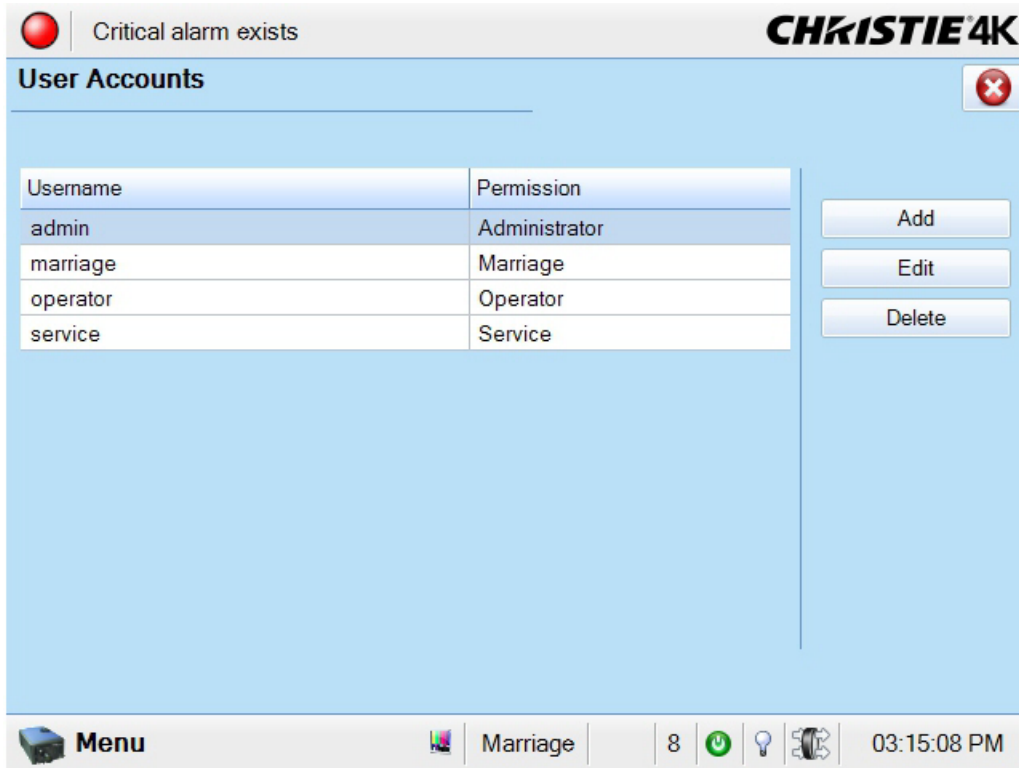


Figure 6-38 Administrator Setup: User Accounts Window

Table 6.30 Administrator Setup: User Accounts Window

Control	Description
User Name and Permission	A list of all users and their permissions.
Add	Adds a username, password and permission level for a new user.
Edit	Edit user passwords and permissions.
Delete	Deletes a user account.

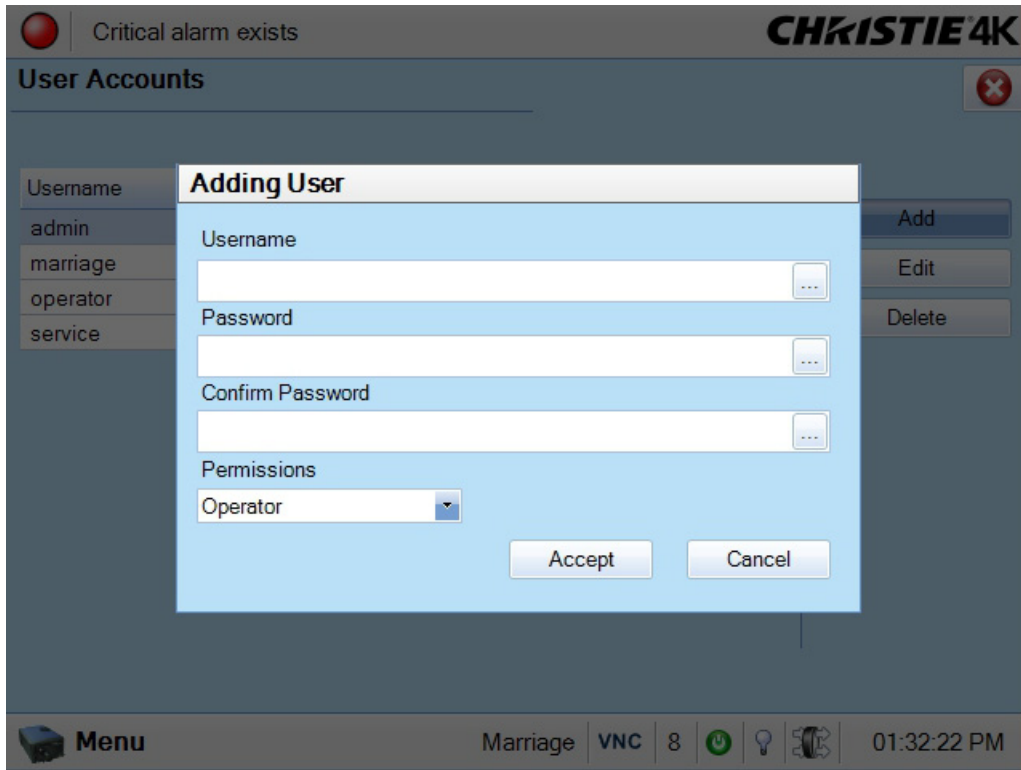


Figure 6-39 Add a New User Window

6.15.13 Upgrade Window

Use the Upgrade window to upgrade the projector software. You must have Administrator or Service permissions to upgrade software.

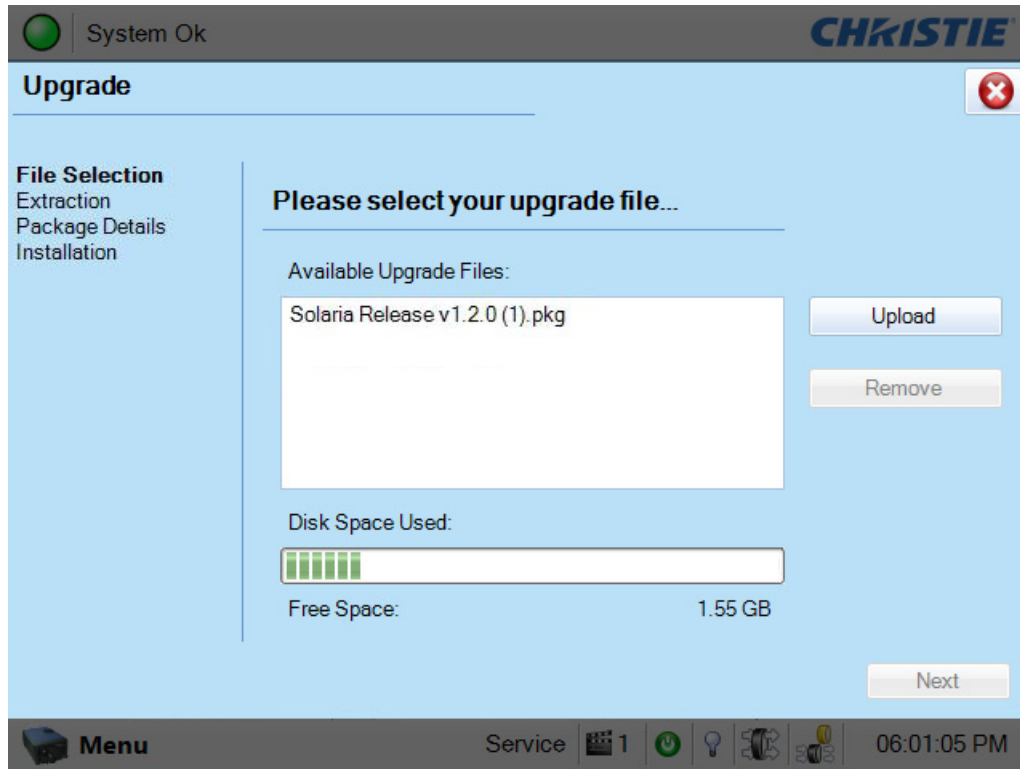


Figure 6-40 Upgrade: File Selection Window

Table 6.31 Upgrade: File Selection Window

Control	Description
Available Upgrade Files	Lists all the upgrades currently stored in the FTP directory of the projector.
Disk Space Used	A visual representation of the amount of used disk space on the projector.
Free Space	The amount of available free space on the projector.
Upload	Uploads a file.
Remove	Deletes an upgrade file.
Next	Opens the Extraction window.

Upgrade: Package Details Window

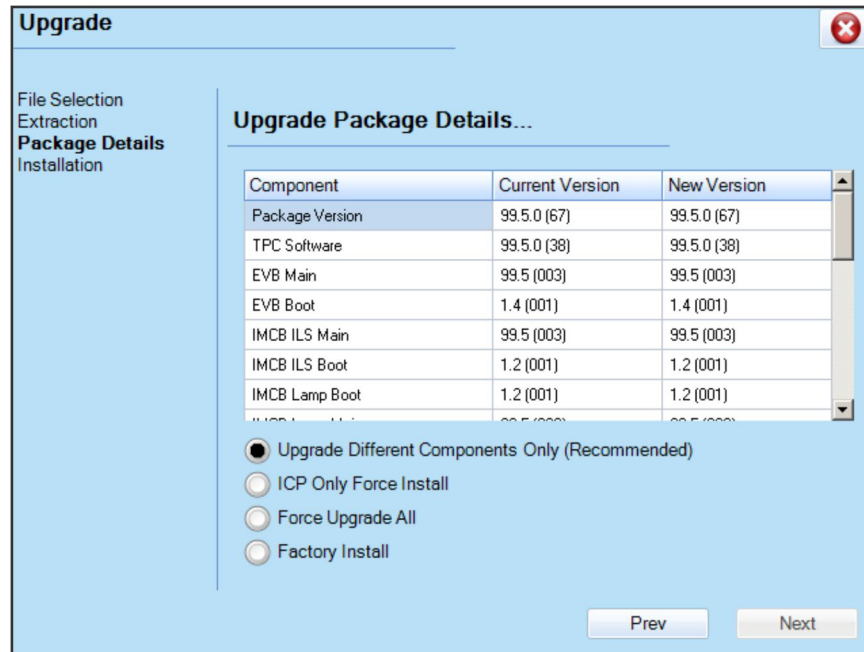


Figure 6-41 Upgrade: Package Details Window

Table 6.32 Upgrade: Package Details Window

Control	Description
Upgrade Different Components Only	Upgrades system components that are newer or older than the currently installed version.
ICP Only Force Install	Forces an ICP install regardless of what current version is installed.
Force Upgrade All	Upgrades all components in the upgrade package.
Factory Install	Removes all configurations and upgrades all components.
Upgrade Different Components Only	Upgrades system components that are newer or older than the currently installed version.

6.16 Service Setup Windows

To open the Service Setup window you need Service permissions.

Use the Service Setup windows to manage backup and restores of projector data.

6.16.1 File Management Window

Use the File Management window to manage backups and restore system settings. Tap **Menu** > **Service Setup** > **File Management**.

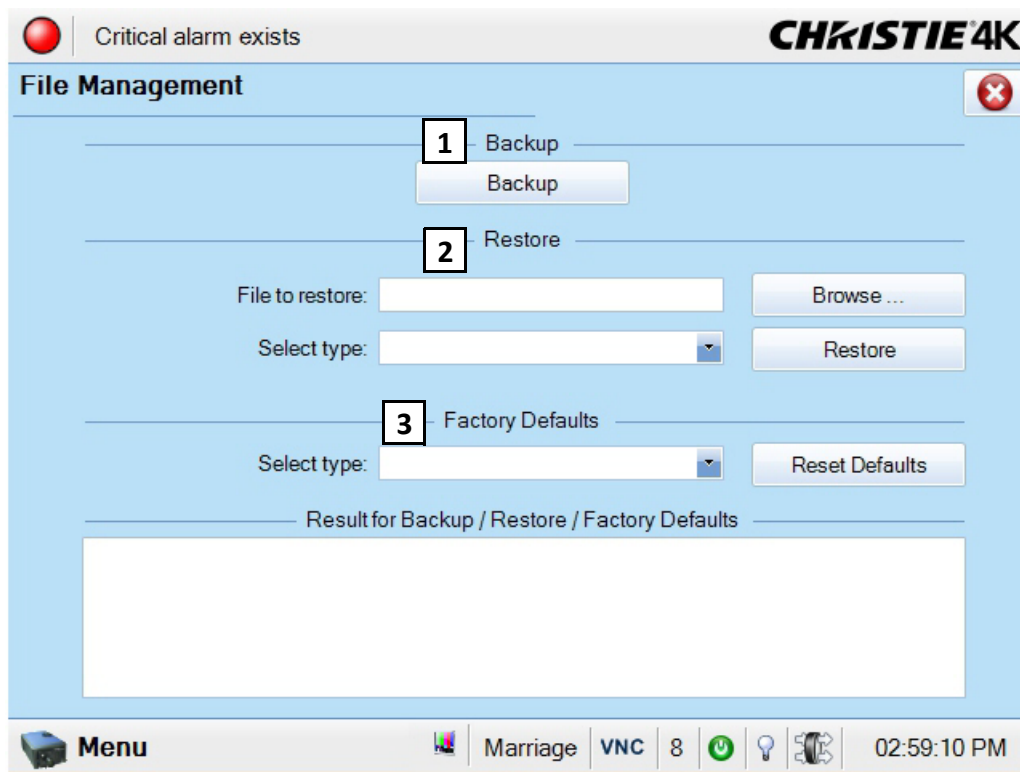


Figure 6-42 Service Setup: File Management Window

Table 6.33 Service Setup: File Management Window

Region	Description
1: Backup	Backs up configuration, preference, channel, and user data to a USB drive or an FTP site.
2: Restore	Restores backup data.
3: Factory Defaults	Resets all information on the projector to the factory default.

Restore Backup Files

1. Tap **Menu** > **Service Setup** > **File Management**.
1. Tap **Browse**.
2. Navigate to the location of the backup file.
3. Select the backup file and click **Open**.
4. In the **Select restore type** list, select a file type.
5. Tap **Restore**.

6.16.2 Marriage Window

Use the **Marriage** wizard to activate marriage on the projector. Marriage engages the Direct Couple Interlock (DCI) and allows you to display secure content. You need Marriage permission to use the Marriage wizard and only Christie accredited technicians are authorized to activate projector marriage.

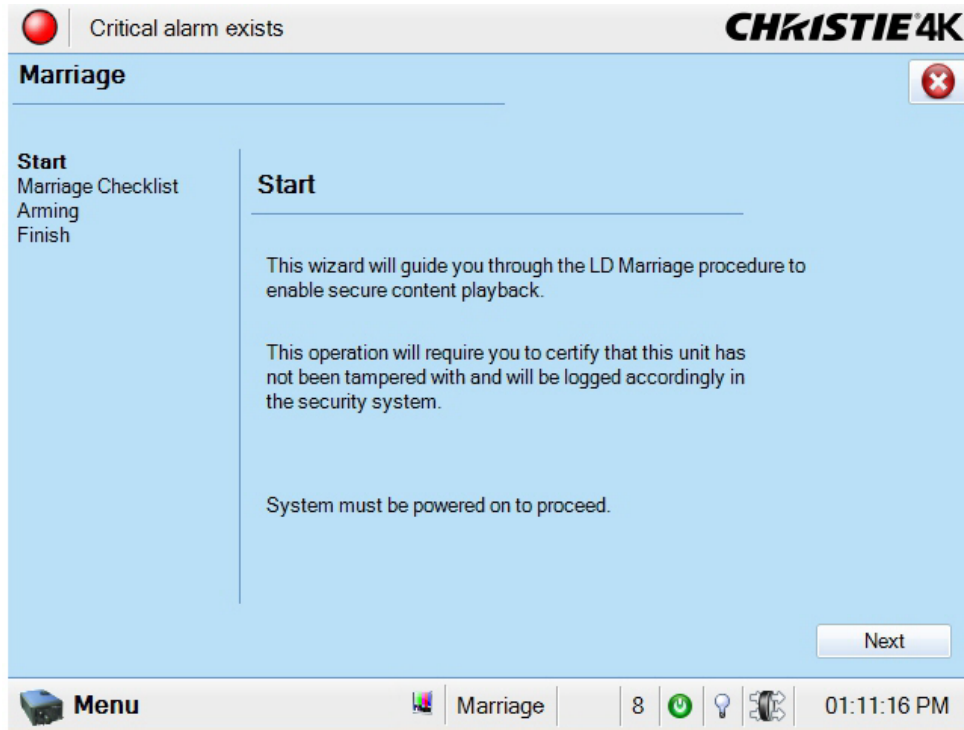


Figure 6-43 Marriage Start Window

6.16.3 Digital Convergence Window

Use the Digital Convergence window to adjust the red, green, and blue digital micromirror devices (DMD) electronically. The maximum adjustment you can make is 3 pixels. When you complete a electronic micromirror adjustment, 1 to 3 pixels are removed from the image.

Do not perform a digital convergence until you manually adjust and set the DMDs. Reset the red, green, and blue DMD values to their default setting before you manually adjust the DMDs.

Tap **Menu** > **Service Setup** > **Digital Convergence**.

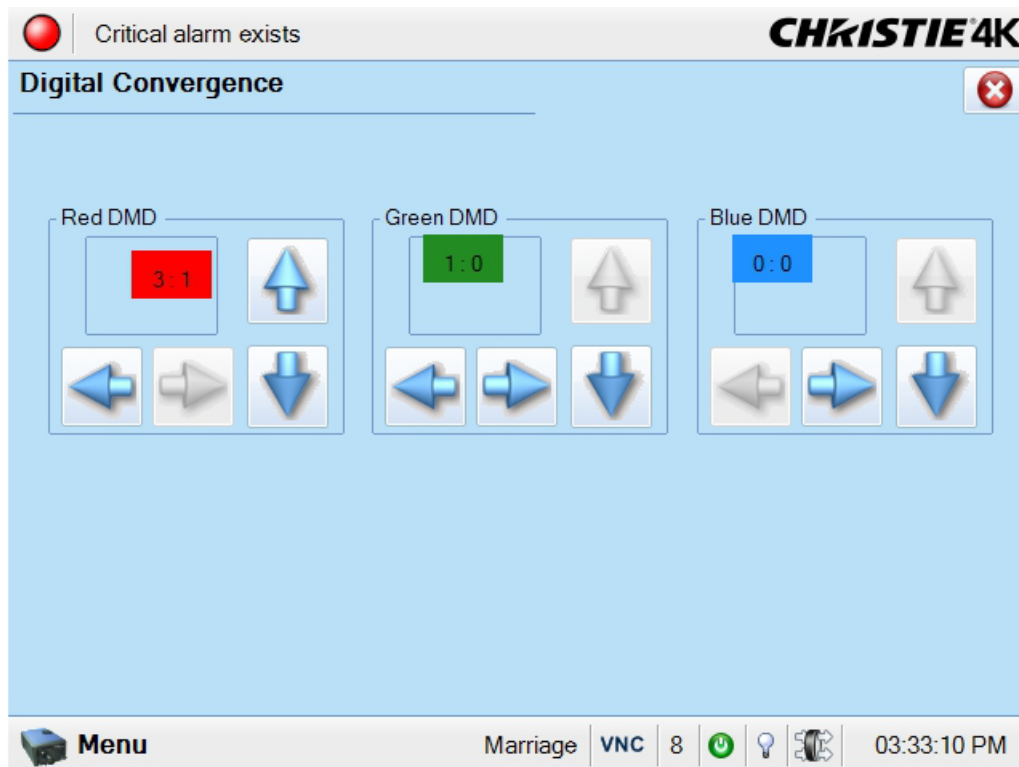


Table 6.34 Digital Convergence Window

Control	Description
Red DMD	Adjusts the red digital micromirror device.
Green DMD	Adjusts the green digital micromirror device.
Blue DMD	Adjusts the blue digital micromirror device.
Default	Returns all digital micromirror devices to the default setting 0:3.

6.16.4 System Access Window

Use the System Access window to access Microsoft Windows functions. Tap **Menu** > **Service Setup** > **System Access**.

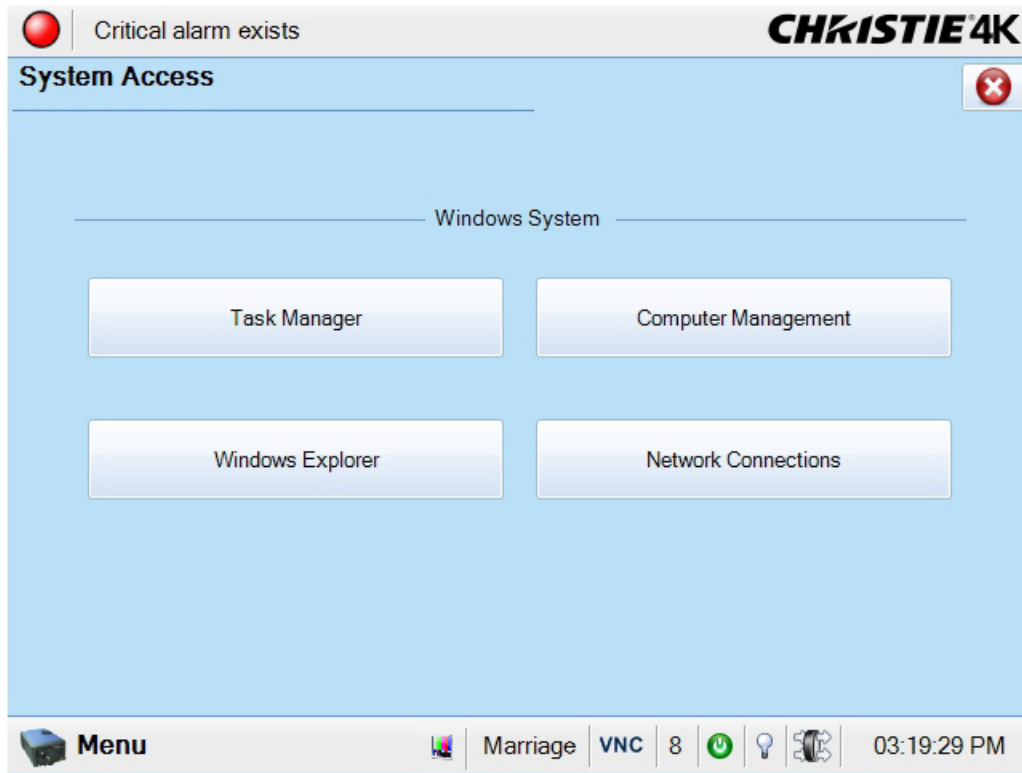


Table 6.35 Service Setup: System Access Window

Control	Description
Task Manager	Opens the Microsoft Windows Task Manager.
Computer Management	Opens the Computer Management window.
Windows Explorer	Opens Windows Explorer.
Network Connections	Opens the Network Connections window.

6.16.5 IMB Marriage Window

Use the Marriage wizard to activate Image Media Block (IMB) marriage on the projector. IMB marriage engages the Direct Couple Interlock (DCI) and allows you to display secure content. You need Marriage permission to use the Marriage wizard and only Christie accredited technicians are authorized to activate IMB marriage.

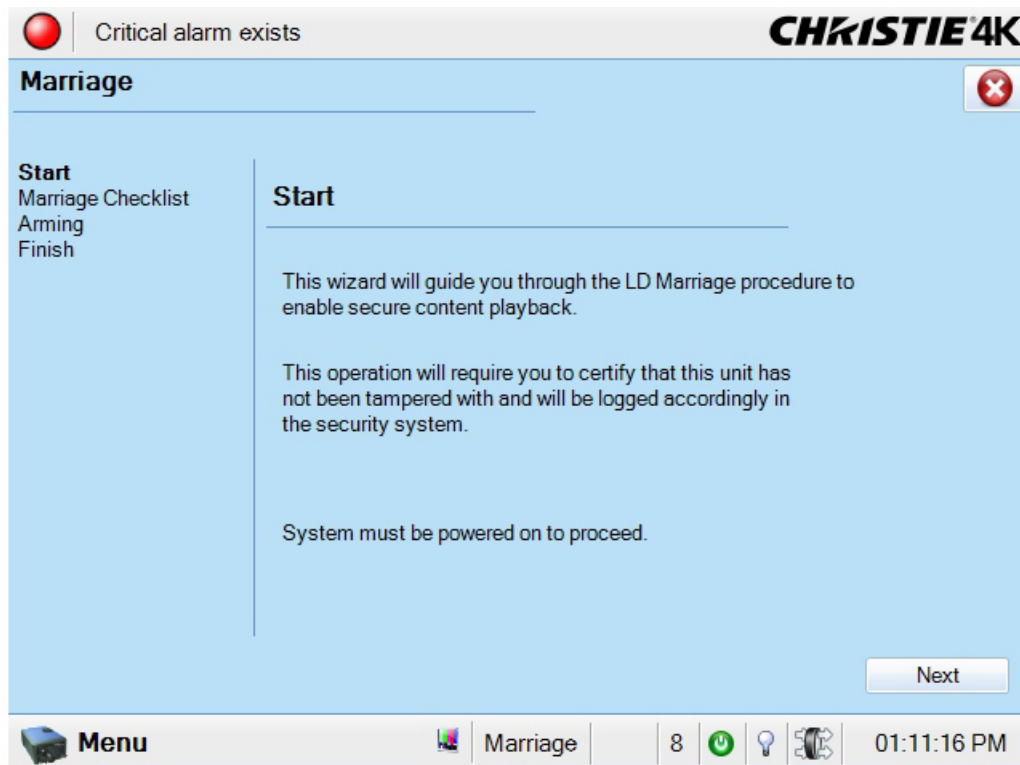


Figure 6-44 Service Setup: IMB Marriage Window

6.16.6 Lamp Power Supply Setup Window

You need Service permission to access the Lamp Power Supply Setup window. Use the Lamp Power Supply Setup window to specify the length of the cable used to connect the projector to an external power supply.

Tap **Menu** > **Service Setup** > **Lamp Power Supply Setup**.

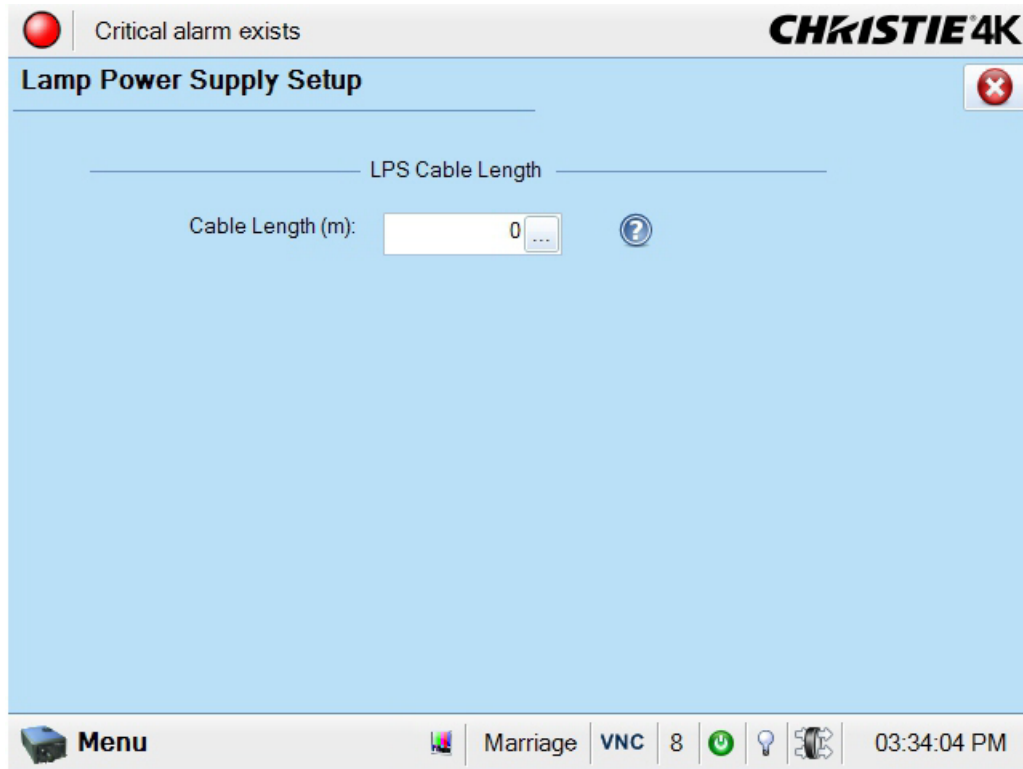


Figure 6-45 Service Setup: Lamp Power Supply Setup Window

6.17 About Window

Use the About window to view information about the projector including the serial number, the current software version, the Digital Light Processing (DLP) version, the lens and lamp type. If the projector has been upgraded, a U appears at the end of the model number.

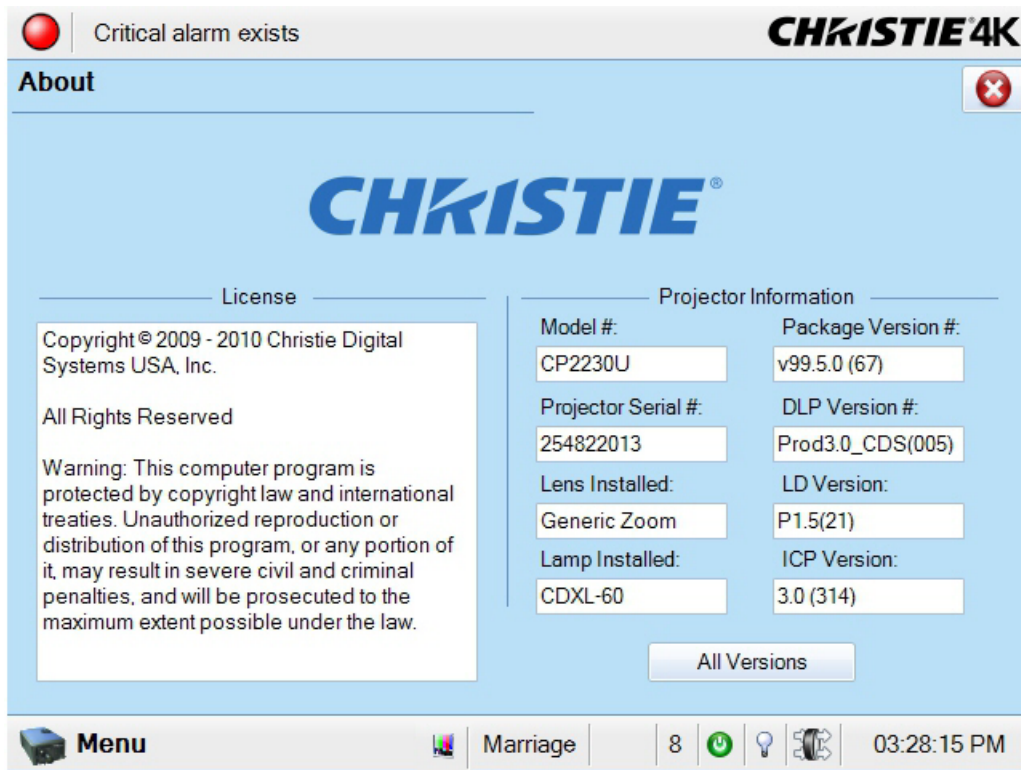


Figure 6-46 About Window

6.18 Help Window

Use the Help window to view information about the Touch Panel Controller (TPC) windows.

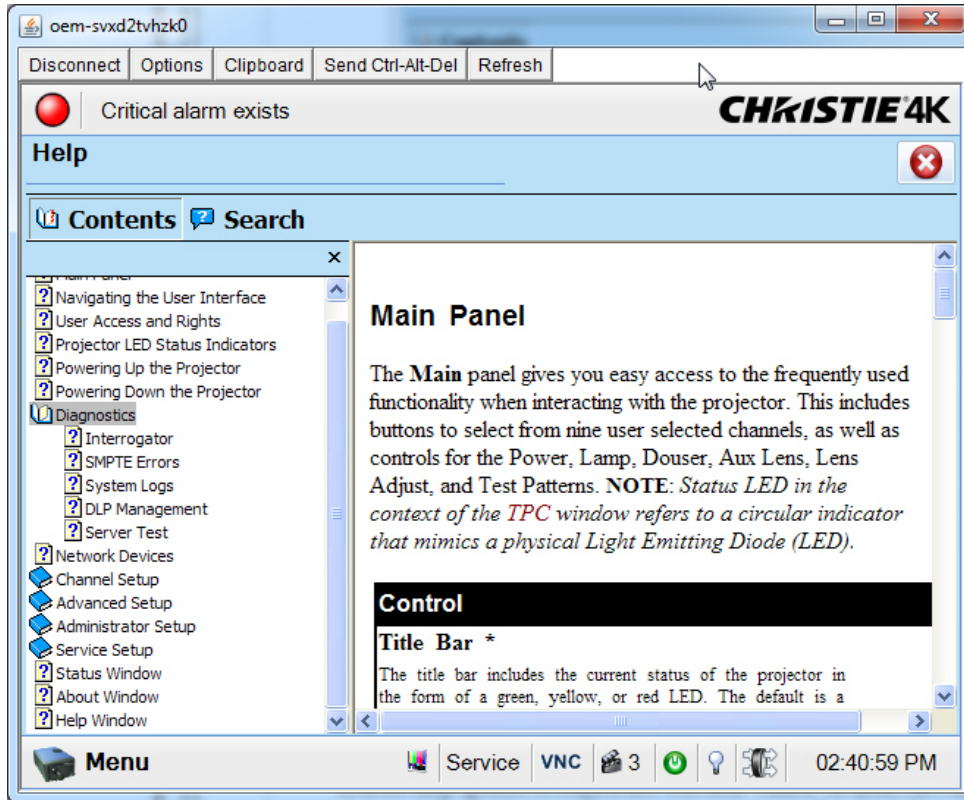


Figure 6-47 Help Window

7 Maintenance

This section provides information and procedures for performing projector maintenance. You should read through this section in its entirety before performing maintenance activities. When you perform projector maintenance, obey all warnings and precautions.

7.1 Inspect Ventilation

Vents and louvers in the projector covers provide ventilation, both for intake and exhaust. Never block or cover these openings. Do not install the projector near a radiator, heat register, or within an enclosure. To ensure adequate airflow around the projector, keep a minimum clearance of 50cm (19.69”) on the left, right, and rear sides of the projector.

7.2 Fill the Coolant Reservoir

⚠ DANGER HAZARDOUS SUBSTANCE! The coolant used in the projector contains ethylene glycol. Use caution when handling. **DO NOT** ingest.

⚠ WARNING Only use coolant recommended by Christie in your projector. Using unapproved coolant can result in projector damage and voids the projector warranty.

The liquid cooler system sends and receives coolant from the digital micromirror device (DMD) heat sinks. Check the coolant level every 6 months, by removing the top projector lid. The coolant level should always be above the minimum level indicator. If the liquid cooling system fails, an over-temperature alarm window appears in the Touch Pad Controller (TPC). The lamp turns off if the projector enters an over-temperature state for longer than one minute.

Top up the coolant with the Christie approved coolant JEFFCOOL E105. Use the refill bottle (with the nozzle) provided in the Liquid Coolant Fill Service Kit (P/N: 003-001837-xx). When refilling, use caution not to spill or let any of the coolant drip on or near the electronics. After filling the reservoir, check the coolant hoses for kinks which may restrict fluid flow.

If coolant drips on electronics or other components, blot the affected area using a dust-free optical grade tissue. It is recommended you blot a few times, discard the tissue and use a new tissue to blot the area again. Keep repeating this cycle until the coolant is removed. Then lightly moisten a new tissue with de-ionized water and blot the area again. Use a dry tissue to dry the area.

7.3 Inspect the Lamp

⚠ DANGER Always disconnect the projector from AC power and wear authorized protective safety gear.

- Check the contact surfaces of the anode (positive) and the cathode (negative) connections for cleanliness.
- Clean electrical contact surfaces regularly to prevent contact resistance from scorching connectors. Use an approved contact cleaner.
- Verify that all electrical and lamp connections are secure.

7.4 Inspect and Clean Optics

Unnecessary cleaning of optics can increase the risk of degrading delicate coatings and surfaces. If you are not a qualified service technician, you can only inspect and clean the lens and lamp reflector. Do not perform maintenance on other optical components. Check these components periodically in a clean, dust-free environment using a high-intensity light source or flashlight. Clean them only when dust, dirt, oil, fingerprints or other marks are obvious. Never touch an optical surface with your bare hands. Always wear latex lab gloves.

These are the recommend tools for removing dust or grease:

- Soft camel-hair brush
- Dust-free blower - filtered dry nitrogen blown through an anti-static nozzle.
- Dust-free lens tissue, such as Melles Griot Kodak tissues (18LAB020), Opto-Wipes (18LAB022), Kim Wipes or equivalent.
- For the lens only - lens cleaning solution such as Melles Griot Optics Cleaning Fluid 18LAB011 or equivalent
- For the reflector only - Methanol.
- Cotton swabs with wooden stems.
- Lens cleaning cloth or microfiber such as Melles Griot 18LAB024 or equivalent.

7.4.1 Clean the Lens

A small amount of dust or dirt on the lens has minimal effect on image quality-to avoid the risk of scratching the lens, clean the lens only if absolutely required.

Remove Dust

1. Brush most of the dust off with a camelhair brush or use a dust-free blower.
2. Fold a microfiber cloth and wipe the remaining dust particles off the lens with the smooth portion of the cloth that has no folds or creases. Do not apply pressure with your fingers. Instead, use the tension in the folded cloth to remove the dust.
3. If significant dust remains on the lens surface, dampen a clean microfiber cloth with lens cleaning solution and wipe gently until clean.

Remove Fingerprints, Smudges, or Oil

1. Brush most of the dust off with a camelhair brush or use a dust-free blower.
2. Fold a microfiber cloth and wipe the remaining dust particles off the lens with the smooth portion of the cloth that has no folds or creases. Do not apply pressure with your fingers. Instead, use the tension in the folded cloth to remove the dust.

7.5 Inspect and Clean the Lamp Blower

NOTICE! DO NOT bend the impeller blades or loosen the balancing weights.

A clogged lamp blower impeller or motor can reduce air flow leading to overheating and failure of the lamp.

1. Vacuum loose dirt from the lamp blower impeller.
2. If necessary, use a brush with hot water.

3. Fold a clean microfiber cloth and dampen with methanol and wipe evenly with the smooth portion of the cloth that has no folds or creases. **Do not apply pressure with your fingers.** Use the solution in the cloth to collect the dirt.

7.6 Clean the Igniter

Clean the high voltage terminal and insulator to remove accumulated dust or dirt.

7.7 Inspect and Clean the Airflow Interlocks

The CP4220 uses two airflow interlocks; a lamp blower vane switch and an extractor vane switch.

The lamp blower vane switch is located within the lamp cooling compartment. The extractor vane switch is located just inside the top duct on the projector lid. Check and clean the switches to remove accumulated dust or dirt that could impede movement if necessary. Within the exhaust duct connected at the top of the projector, adequate airflow must be maintained and routed outside of the building. Inspect regularly and confirm that 1) there are no obstructions or “kinks” within the ducting, 2) all air intake areas are unobstructed, and 3) exhaust airflow is at least 450 CFM* (measured at the rigid end of the duct when not connected to the projector). Refer to [7.1 Inspect Ventilation, on page 7-1](#).


*** 600 CFM is required in projection rooms with ambient temperature above 25°C or elevation (above sea level) greater than 3000 feet.**

7.8 Inspect the Laminar Airflow Device (LAD)

The LAD filter is attached to the light engine assembly handle in the light engine compartment. Inspect the LAD filter every six months. If the LAD filter is dark grey, contact Christie or your dealer for replacement.

7.9 Replace the Lamp

⚠ DANGER 1) Lamp replacement must be performed by a qualified service technician only. 2) **EXPLOSION HAZARD.** Wear authorized protective clothing whenever the lamp door is open and when handling the lamp. Never twist or bend the quartz lamp body. Use the correct wattage lamp supplied by Christie. 3) Ensure those within the vicinity of the projector are also wearing protective safety clothing. 4) Never attempt to remove the lamp when it is hot. The lamp is under a great deal of pressure when hot and may explode, causing personal injury or death and/or property damage. Allow the lamp to cool completely before replacing it.

1. Click  on the TPC **Main** panel to turn the lamp and main AC OFF. Allow the internal cooling fans to run for at least 10 minutes to cool the lamp.
2. When the cooling fans stop, unplug the projector.
3. Wearing authorized protective safety gear, unlock and open the lamp door. If desired, release the latch mechanism to remove the door entirely.
4. Remove the front lamp duct to reveal the cathode end (-) of the lamp.
5. Loosen set screws from the negative cathode and the positive anode lamp connectors. Make sure to apply minimal torque and DO NOT STRESS the quartz tube. (Figure 7-1).

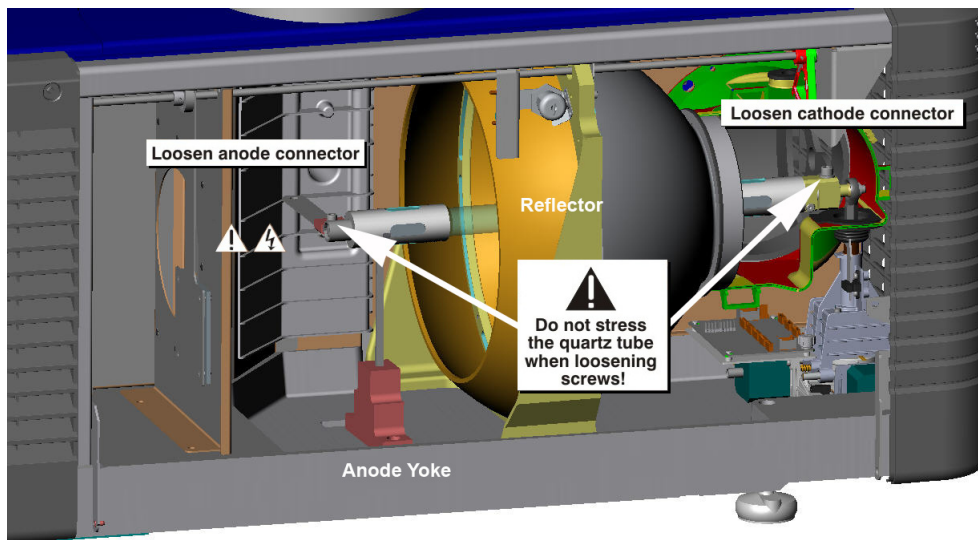


Figure 7-1 Removing the Lamp

6. Carefully slide the positive anode connector off the front of the lamp.
7. Holding the cathode end of the lamp, unscrew the lamp from the cathode connector. Carefully remove the lamp from the projector and immediately place it inside the protective cover or original packaging.
Caution! Handle the lamp by the cathode/anode end shafts only, never the glass.
8. Place the lamp on the floor where it cannot fall or be bumped. **Warning!** Handle box with extreme caution - the lamp is hazardous even when packaged. Dispose of lamp box according to safety regulations for your area.
9. With the lamp removed, visually inspect the reflector for dust. Clean the reflector if necessary. See [Inspect and Clean Optics](#).
10. Remove the tape, knurled nut, and locking star washer securing the lamp within its cover.
11. If you are installing a different type of lamp from the original, ensure the correct position of the anode yoke. See [Section 2: Install the Lamp](#).
12. Insert the threaded cathode (-) end of the lamp into the negative lamp connector nut located in the rear of the lamp compartment. **(Figure 7-2)** Using both hands, hand-tighten this end into the threaded nut.
Caution! 1) Handle the lamp by the cathode/anode end shafts only, never the glass. **DO NOT** over-tighten. **DO NOT** stress the glass in any way. **2)** Check leads. Make sure the anode (+) lead between the lamp and igniter is well away from any projector metal such as the reflector or firewall.
13. Rest the anode (+) end of the lamp on the anode yoke and slip the positive lamp connector over the bulb end. **(Figure 7-2)** Using the 5mm Allen key, squeeze together with the anode clamp making sure not to place any torque on the lamp quartz tube. **Important!** Ensure that the “flat” part of the anode end of the lamp is facing up. **Warning!** Explosion hazard - Do not apply torque to the anode end of the lamp.
14. Tighten the negative and positive lamp connector screws. **Important!** Proper electrical contact prevents resistance in the lamp connectors. **Caution! 1)** Handle the lamp by the cathode/anode end shafts only, never the glass. **DO NOT** over-tighten. **DO NOT** stress the glass in any way. **2)** Check leads. Make sure the

anode (+) lead between the lamp and igniter is well away from any projector metal such as the reflector or firewall.

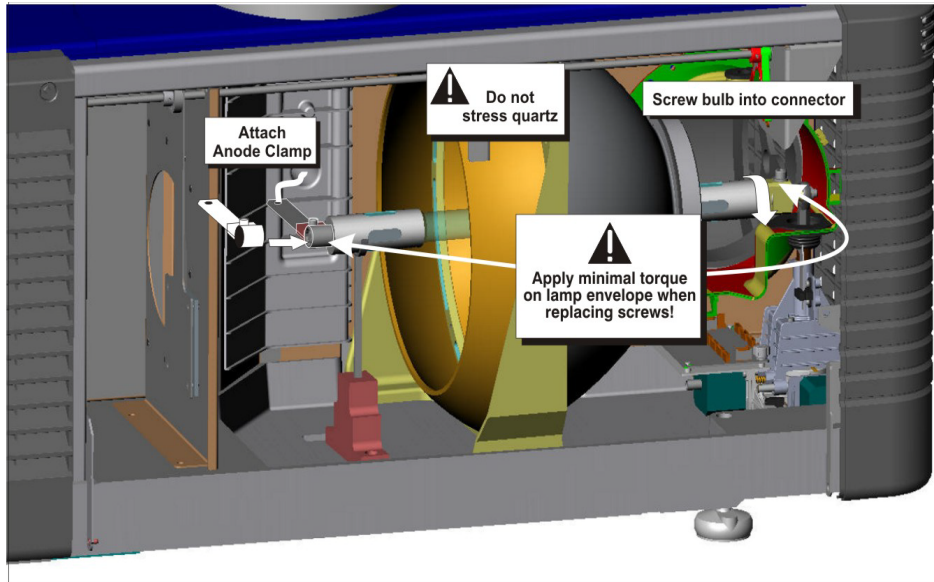
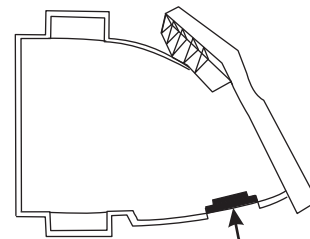


Figure 7-2 Installing the Lamp

15. Re-install the Front Lamp Duct

NOTE: It is critical that you lift the small light shield on the rear lamp duct cover so that it does not get jammed between the two pieces when they come together. (**Figure 7-3**) To ensure a good fit between the two pieces, squeeze the top and bottom cover snaps to ensure they are locked in place. The light shield should move freely to the touch.



Lift rear light shield when installing front lamp duct

Figure 7-3 Light Shield on Front Lamp Duct

16. Close Lamp Door.
17. Turn Wall Circuit ON.

18. In the **Advanced Setup: Lamp History** window, click the **Add Lamp** button and record lamp type, serial number, reason for change and number of the hours logged on to the lamp. If the lamp has not been previously used, enter 0. Click **Save** to save the data entered. (**Figure 7-4**)

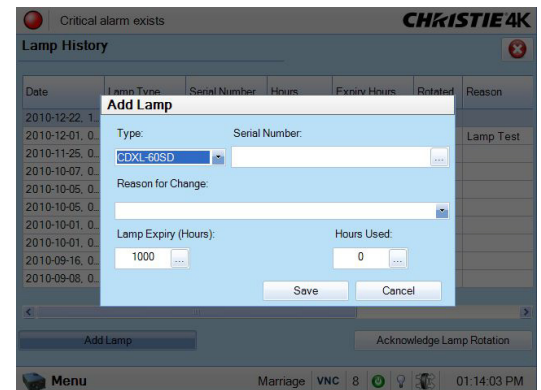




Figure 7-4 Add Lamp Window

19. Click  from the TPC **Main** panel to turn the lamp on.
20. **Open the LampLOC** window. Run LampLOC to optimize light output.

7.10 Rotate the Lamp

⚠ DANGER 1) Lamp rotation must be performed by a qualified service technician only. 2) **EXPLOSION HAZARD!** Wear authorized protective clothing whenever the lamp door is open and when handling the lamp. Never twist or bend the quartz lamp body. Use the correct wattage lamp supplied by Christie. 3) Ensure those within the vicinity of the projector are also wearing protective safety clothing. 4) Never attempt to remove the lamp when it is hot. The lamp is under pressure when hot and may explode, causing personal injury, death, or property damage. Allow the lamp to cool completely.

When the operational life of the lamp reaches halfway, it is recommended that you rotate it 180° to ensure an even burn of the lamp, improve lamp performance, and extend the life of the lamp. An alarm window appears on the TPC after you complete the lamp rotation.

1. Tap and hold the red power button  on the TPC **Main** panel to turn the lamp and projector off.
2. Allow the lamp to cool for a minimum of 10 minutes.
3. Unplug the projector.
4. Put on your protective clothing and face shield.
5. Unlock and open the lamp door. Release the tethered latch mechanism to remove the door entirely.
6. Remove the cathode cable and rotate the lamp 180°.
7. Replace the cathode cable.
8. Replace and lock the lamp door.
9. Remove your protective clothing and face shield.
10. Tap and hold the green power button to turn the projector on.
11. Tap **Menu > Advanced Setup > Lamp History**.
12. Tap **Acknowledge Lamp Rotation**.

7.11 Replace the Light Engine Air Filter

⚠ CAUTION Use only high efficiency Christie approved filters. Never operate the projector without the filter installed. Always discard used air filters.

You should check the condition of the light engine air filter monthly. Replace the light engine air filter when you replace the lamp module or sooner if you are operating the projector in a dusty or dirty environment. The filter is located on the right side of the projector behind the air filter cover.


1. Release two tabs on the air filter cover and remove.
2. Slide the air filter out and discard. Insert the new air filter with the airflow indicator facing toward the projector. **NOTE:** *Never reuse an old air filter. The air filters in this product cannot be cleaned thoroughly enough for reuse and can lead to the contamination of optical components.*
3. Install the air filter cover by inserting the two bottom tabs into place and then snapping the door closed.

7.12 Replace the Liquid Cooling Air Filter

The radiator air filter is located on left/front side of the projector behind a small air filter cover.

1. Release a single tab on the air filter cover and remove.
2. Slide the air filter out and discard. Insert the new air filter with the air flow indicator facing toward the projector. **NOTE:** *Never reuse an old air filter. The air filters in this product cannot be cleaned thoroughly enough for reuse and can lead to the contamination of optical components.*
3. Install the air filter cover by inserting the bottom tabs into place and then snapping the door closed.

7.13 Replace the Lens

1. Tap and hold the red power button  on the TPC **Main** panel to turn the lamp and projector off.
2. Allow the lamp to cool for a minimum of 10 minutes.
3. Unplug the projector.
4. Remove the shroud.
5. Turn the lens clamp to the OPEN/UP position.
6. Release the lens locking lever (UP position).
7. Pull out the lens and replace it with a different high-brightness lens. **NOTE:** *Always install the lens with “UP” label in the top position. This will assist in achieving consistent boresight alignment each time the lens is replaced. See [2.9 Install the Primary Lens, on page 2-9](#).*
8. Secure the lens with the lens locking lever (DOWN position).
9. Calibrate the lens.
10. Install the shroud.

8 Troubleshooting

This section provides information and procedures for resolving common projector issues. If you cannot resolve a projector issue, contact a Christie accredited service technician.

8.1 Projector Does Not Turn On

- Check the wall circuit breaker to see if it is ON. If there is a problem with the wall circuit breaker, have a certified electrician investigate any electrical problem.
- Check the status of the LEDs on the rear corners of the projector. (Figure 8-1). If there is no activity, see #3.
- Verify power by looking through the rear, right side grill. One LED should be present in the upper right. This indicates the LVPS has power. Another LED should be seen in the lower left indicating Main input. (Figure 8-2)
- On the TPC, verify in the **Operational Status** region of the **Main** panel that there is no failure with PIB communication (PIB Status).

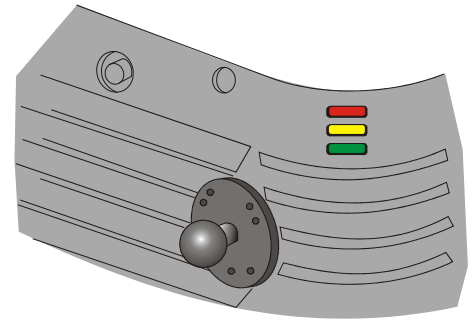


Figure 8-1 Projector Status LEDs

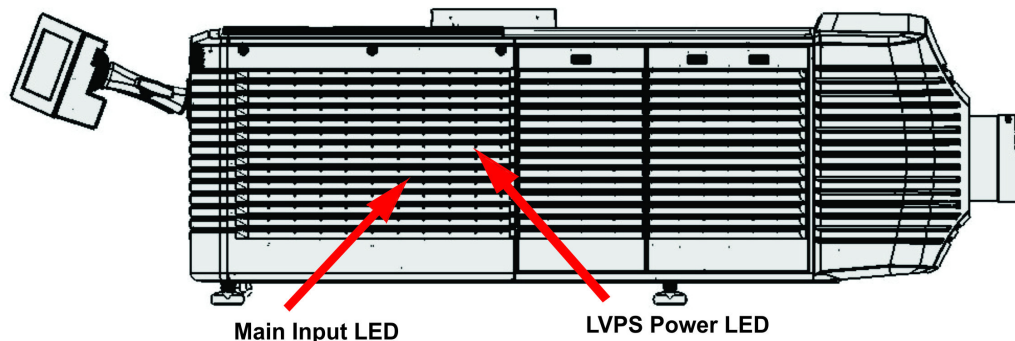


Figure 8-2 View Power Status LEDs

8.2 Lamp Does Not Ignite

- Tap **Menu** > **Advanced Setup** > **Lamp History** and verify the number of hours the lamp has operated. Replace a lamp nearing the end of its operational life
- Tap **Menu** > **Status** and then **Interlocks** in the left pane. Check and correct all interlock failures.
- Tap **Menu** > **Status** and then **All Alarms** in the left pane. If a ballast communication error has occurred, restart the projector and turn the lamp on.
- Tap **Menu** > **Status** and then **Temperatures** in the left pane. Verify if the DMD temperatures are too high. If the temperatures are too high, cool the projector. Ensure the projector is properly ventilated, the air filters are not blocked, and the liquid cooling reservoir has coolant.
- Listen for a clicking noise that indicates the ballast is attempting to strike the lamp. If you do not hear a clicking noise, there might be a problem a problem with the ballast. Contact a Christie accredited service technician to resolve the issue.

- If you hear a brief clicking noise, but the lamp does not ignite, replace the lamp.
- Check the transformer Voltage switch on the transformer.

8.3 Lamp Suddenly Turns Off

- Tap **Menu** > **Advanced Setup** > **Lamp Power/LiteLOC Setup**. Increase the lamp power.
- Tap **Menu** > **Status** and then **Interlocks** in the left pane. Review and correct all interlock failures.
- If EVB errors occur, check the door interlock.
- Tap **Menu** > **Status** and then **Temperatures** in the left pane. Verify if the DMD temperatures are too high. If the temperatures are too high, cool the projector. Ensure the projector is properly ventilated, the air filters are not blocked, and the liquid cooling reservoir has coolant.
- Replace the lamp.

8.4 Flicker, Shadows, Or Dimness

- Ensure the douser is open.
- Run a LampLOC™ adjustment.
- Verify that a LampLOC™ adjustment is not in progress.
- Tap **Menu** > **Advanced Setup** > **LampPower/LiteLOC™ Setup**. Monitor the Power% field to determine if the power is consistent or varying. Increase the lamp power. Lamps which are near end of service may not operate reliably at a lower power setting.
- Fold mirror misalignment. Contact your Christie accredited service technician to resolve the issue.
- Integrator rod misalignment. Contact your Christie accredited service technician to resolve the issue.

8.5 LampLOC™ Not Working

- If the **Do Auto** option is not working, tap **Menu** > **Advanced Setup** > **LampLOC™ Setup** and adjust the lamp position manually. Observe screen brightness by adjusting the XYZ values or use a light meter to check for changes in brightness.
- Check that the anode yoke (lamp yoke) is in the correct position. (Figure 8-3)
- Check that the flat part of the anode end of the lamp (if applicable) faces up in the anode yoke. For CDXL-20 and CDXL-30 lamps, the flat part of the anode end of the lamp should be positioned at the 2 or 10 o'clock position.

8.6 LiteLOC™ Not Working

- Tap **Menu** > **Advanced Setup** > **LampPower/LiteLOC™ Setup**. Tap **Enable LiteLOC™**.
- If the lamp power is at the maximum setting to maintain a LiteLOC™ setting, LiteLOC™ is automatically disabled. Reduce the LiteLOC™ setting, or install a new lamp.

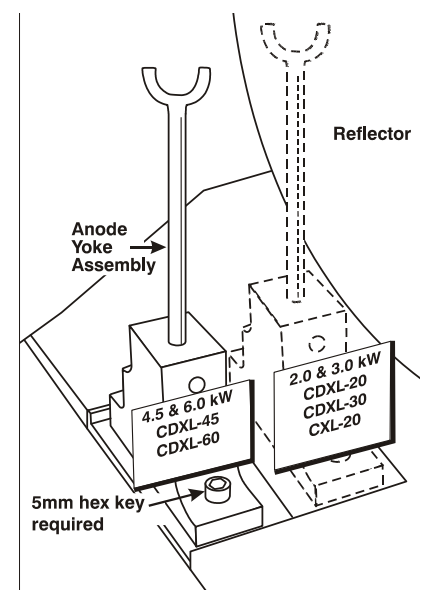


Figure 8-3 Lamp Yoke Position

8.7 Touch Panel Controller (TPC)

- If the TPC does not appear, restart the projector.
- If the TPC display is blank, ensure the TPC is on by opening the flap at the back of the TPC and verify the grey button in the bottom left corner is ON.
- If the button taps on are misinterpreted, the TPC screen may need recalibrating. Tap **Menu > Administrator Setup > Preferences**. Tap **Calibrate Screen** and follow the instructions on the screen.

8.8 Trouble Establishing Communication with Projector

Verify all input devices have the same subnet mask and unique IP addresses.

1. From the Desktop Launcher, **Administrator Setup: Communication Configuration** menu, check the **IP Address** and **Management IP** address with the **Subnet Mask address**. Ensure these belong to the same network.

8.9 Blank Screen, No Display of Cinema Image

- Ensure the lens cap is not on either end of the lens.
- Ensure the lamp is ON.
- Confirm all power connections are OK.
- Ensure the douser is OPEN by verifying the state of the douser on Main panel as well as the state of the douser switch at the back of the projector in the top, left corner.
- Ensure any test pattern other than the full black test pattern displays properly.
- Verify the correct display file is selected?
- For cinema connections, verify the correct port is used.

8.10 Severe Motion Artifacts

Verify if there is a synchronization problem with reversed 3-2 pull-down in the 60Hz-to-24Hz film-to digital conversion and correct it at the source.

8.11 Image Appears Vertically Stretched or 'Squeezed' into Center of Screen

To regain full image width and proper proportions you may need to install an anamorphic lens. Open the Source File Setup window and verify the resolution and aspect ratio settings. Open the Screen File Setup window and verify the lens factor settings.

8.12 No Image, Just Pink Snow

This problem occurs when the correct cryptographic key is not available to decode encrypted cinema content..

- If the projector security lid is unlocked or open, a warning appears on the Touch Panel Controller (TPC). Pause or stop the show on the server and then close and lock the lid. Press Play on the server and wait for the projector to receive the decryption keys from the server. If the projector does not recover after 30 seconds, pause or stop the show and try pressing Play again. If this solution does not work, reset the server. Check the Status window on the TPC for a tamper warning. If the lamp door is closed, the tamper switch may be faulty.

- Ensure the IP octets for the projector and the server match. Change if necessary.
- Tap **Menu** > **Channel Setup**. Tap **Config 2** in the left pane and select **LD Bypass**.

8.13 Inaccurate Display Colors

Adjust the color, tint, color space, and color temperature settings of your input source. Tap **Menu** > **Channel Setup**. Tap **Config 1** in the left pane and verify the correct value is selected in the **PCF** list. Tap **Config 2** in the left pane and verify the correct value is selected in the **Color Space** field.

8.14 Display is Not Rectangular

- Verify the projector is level and the lens surface and screen are parallel to one another.
- Adjust the vertical offset of the lens mount with the vertical offset knob or ILS.
- Check that the anamorphic lens is straight. Rotate to orient the aperture correctly.
- Tap **Menu** > **Advanced Setup** > **Screen File Setup** and verify the settings for the screen file are correct.

8.15 Display is Noisy

- Adjust the input source pixel tracking, phase, and filter.
- Verify the video input is terminated (75 ohms). If the device is the last device in a linked series, verify the video input is terminated at the last input source.
- Verify the cables connecting the input device to the projector meet the minimum requirements.
- Add signal amplification or conditioning if the distance between the input device and the projector exceeds 25 feet.


8.16 Display has Suddenly Frozen

Turn off the projector and unplug the power cord from the power source. Plug the projector power cord into a power source and turn the projector on.

8.17 Data is Cropped from Edges

Reduce the image size to fill the display area, and then stretch the image vertically to fill the screen. Add an anamorphic lens to regain image width. See [6.14.7 Screen File Setup Window](#).

8.18 The Projector is ON, but There is No Image

- Ensure AC power is connected.
- Make sure the lens cover is removed from the lens.
- Make sure the douser is open.
- Tap  on the main TPC screen. If the lamp does not strike, see [8.2 Lamp Does Not Ignite, on page 8-1](#).
- Tap **Menu** > **Channel Setup**. Verify the correct channel is selected and the settings are correct.
- Ensure an active source is connected properly. Check the cable connections and make sure the alternative source is selected.

- Verify you can select test patterns. If you can, check your source connections again.
- Ensure your Cinema server is running Series 2 compatible software.

8.19 The Display is Jittery or Unstable

- Verify that the input device is connected properly. If the input device is not connected properly, the projector repeatedly attempts to display an image.
- The horizontal or vertical scan frequency of the input signal may be out of range for the projector. See [Section Appendix A: Specifications](#) for scan frequency ranges.
- The sync signal may be inadequate. Correct the source problem.

8.20 The Display is Faint

- Verify the input source is terminated only once.
- If the input is not a video source, use a different sync tip clamp location.

8.21 Portions of the Display are Cut OFF or Warped to the Opposite Edge

If you have resized the image, adjust the resizing settings until the entire image is visible and centered. See [6.14.7 Screen File Setup Window](#).

8.22 Display Appears Compressed (Vertically Stretched)

- Adjust the frequency of the pixel sampling clock for the input source.
- Verify the size and position settings are correct for the input source.
- Use an anamorphic lens for HDTV and anamorphic DVD input sources that have been re-sized and vertically stretched.

8.23 Inconsistent Picture Quality

- Verify the quality of the signal from the input source.
- Verify the H and V frequencies of the input source are correct.

Appendix A: Specifications

This section provides detailed CP4220 specifications. Due to continuing research, specifications are subject to change without notice.

A.1 Display

A.1.1 Panel Resolution and Refresh Rate

Pixel format (H x V square pixels)	2048 x 1080/4096 x 2160
Processing path	23.97 - 120Hz
3D (24 fps per eye input, DLP Cinema® Processing), Full Image (2048 x 1080)	144Hz (frame tripled)

A.1.2 Achievable Brightness (Measured at Screen Center)

	<u>Nominal</u>	<u>Maximum</u>
2.0kW (CDXL-20)	8,000 lumens	10,000 lumens
3.0kW (CDXL-30)	14,000 lumens	16,000 lumens
3.0 kW (CDXL-30SD)	18,500 lumens	23,500 lumens

A.1.3 Achievable Contrast Ratio

450:1 ANSI, 1850:1 Full Frame ON/OFF

A.1.4 Color and Gray Scale

Displayable colors	35.2 trillion
Gray Scale resolution	45 bits total linear, 15 bits per RGB component

A.1.5 White Point

Theatres:

Nominal White (<i>full white, after calibration to Telecine mode</i>)	$x = 0.314 \pm 0.006$ $y = 0.351 \pm 0.006$
---	--

A.1.6 Gamma

Theater (nominal)	2.6 ±5%
-------------------	---------

A.2 Source Signal Compatibility

A.2.1 Cinema Inputs

- Number of inputs 2
- Standard supported SMPTE 292M bit-serial

- Connector type BNC

Table A.1 Standard Single-link SMPTE 292M Formats

Source Standard	Original Source Resolution	Vertical Frequency (Hz)	Scan Type	Display Frame Rate (Hz)
	640 x 480	up to 60	Progressive	up to 60
	720 x 525	up to 60	Interlaced	up to 60
SMPTE 296M	1280 x 720	23.98 / 24	Progressive	23.98 / 24
SMPTE 296M	1280 x 720	25	Progressive	25
SMPTE 296M	1280 x 720	29.97 / 30	Progressive	29.97 / 30
SMPTE 296M	1280 x 720	48	Progressive	48
SMPTE 296M	1280 x 720	50	Progressive	50
SMPTE 296M	1280 x 720	59.94 / 60	Progressive	59.94 / 60
SMPTE 274M	1920 x 1080	23.98 / 24	Progressive	23.98 / 24
SMPTE 274M	1920 x 1080	25	Progressive	25
SMPTE 274M	1920 x 1080	29.97 / 30	Progressive	29.97 / 30
SMPTE 295M	1920 x 1080	50	Interlaced	25
SMPTE 274M	1920 x 1080	50	Interlaced	25
SMPTE 274M	1920 x 1080	59.94 / 60	Interlaced	29.97 / 30
SMPTE RP 211	1920 x 1080	23.98 / 24	Progressive (sF)	23.98 / 24
SMPTE RP 211	1920 x 1080	25	Progressive (sF)	25
SMPTE RP 211	1920 x 1080	29.97 / 30	Progressive (sF)	29.97 / 30
SMPTE 428-9	2048 x 1080	24	Progressive	24
SMPTE 428-9	2048 x 1080	24	Progressive (sF)	24
SMPTE 428-19	2048 x 1080	25	Progressive	25
SMPTE 428-19	2048 x 1080	25	Progressive (sF)	25
SMPTE 428-19	2048 x 1080	30	Progressive	30
SMPTE 428-19	2048 x 1080	30	Progressive (sF)	30

NOTES: 1) All formats supported at 10 bit 4:2:2 YCbCr or lower. ** DCI formats (SMPTE 428-9) are supported at 12 bit 4:4:4 XYZ. **2)** When both SMPTE 292M inputs are used together in a dual-link configuration (SMPTE 372M) they will support all the formats listed in Section Table A.1 in 4:4:4 YCbCr or RGB format with 10 or 12 bits per component. Also supported is 4:2:2 YCbCr progressive input with 10 or 12 bits per component and a pixel format of 1920 x 1080 at 47.96 or 48 fps. **3)** For 3D content, the supported format is 4:2:2 YCbCr 10 bit per eye.

Table A.2 Standard Dual-link SMPTE 372M Formats

Source Standard	Original Source Resolution	Vertical Frequency (Hz)	Scan Type	Display Frame Rate (Hz)
	640 x 480	up to 60	Progressive	up to 60
	720 x 525	up to 60	Interlaced	up to 60
SMPTE 296M	1280 x 720	23.98 / 24	Progressive	23.98 / 24
SMPTE 296M	1280 x 720	25	Progressive	25
SMPTE 296M	1280 x 720	29.97 / 30	Progressive	29.97 / 30
SMPTE 296M	1280 x 720	48	Progressive	48
SMPTE 296M	1280 x 720	50	Progressive	50
SMPTE 296M	1280 x 720	59.94 / 60	Progressive	59.94 / 60
SMPTE 274M	1920 x 1080	23.98 / 24	Progressive	23.98 / 24
SMPTE 274M	1920 x 1080	25	Progressive	25
SMPTE 274M	1920 x 1080	29.97 / 30	Progressive	29.97 / 30
SMPTE 295M	1920 x 1080	50	Interlaced	25
SMPTE 274M	1920 x 1080	50	Interlaced	25
SMPTE 274M	1920 x 1080	59.94 / 60	Interlaced	29.97 / 30
SMPTE RP 211	1920 x 1080	23.98 / 24	Progressive (sF)	23.98 / 24
SMPTE RP 211	1920 x 1080	25	Progressive (sF)	25
SMPTE RP 211	1920 x 1080	29.97 / 30	Progressive (sF)	29.97 / 30
SMPTE 428-9	2048 x 1080	24	Progressive	24
SMPTE 428-9	2048 x 1080	24	Progressive (sF)	24
SMPTE 428-19	2048 x 1080	25	Progressive	25
SMPTE 428-19	2048 x 1080	25	Progressive (sF)	25
SMPTE 428-19	2048 x 1080	30	Progressive	30
SMPTE 428-19	2048 x 1080	30	Progressive (sF)	30
SMPTE 292 x 2	2048 x 1080	24 x 2	Progressive	96 or 144

A.2.2 Non-Cinema DVI Inputs (for Alternate Content)

- Number of inputs 2
- Standard supported VESA Digital Visual Interface (DVI-D)
- Connector type 24-pin female DVI-D

Table A.3 Format for Generic Inputs to DVI-D Ports, Single-Link

NOTE: All formats listed are 4:4:4 RGB.

Source Pixel Format	Bits / Comp	Vertical Rates
640 x 480	8	59.94 / 60 Hz
1280 x 720	8	59.94 / 60 Hz
1920 x 1080	8	59.94 / 60 Hz
720 x 480	8	59.94 / 60 Hz
1280 x 720	8	50 Hz
1920 x 1080	8	50 Hz
1440 x 480	8	59.94 / 60 Hz
1920 x 1080	8	59.94 / 60 Hz
1440 x 576	8	50 Hz
1920 x 1080	8	23.98 / 24 Hz
1920 x 1080	8	25 Hz
1920 x 1080	8	29.97 / 30 Hz

Table A.4 Format for Generic Inputs to DVI-D Ports, Twin-Link

NOTE: All formats listed are 4:4:4 RGB.

Source Pixel Format	Bits / Comp	Vertical Rates
640 x 480	10	59.94 / 60 Hz
1280 x 720	10	59.94 / 60 Hz
1920 x 1080	10	59.94 / 60 Hz
1280 x 720	10	50 Hz
1920x1080	10	50 Hz
1440 x 480	10	59.94 / 60 Hz
1920 x 1080	10	59.94 / 60 Hz
1440 x 576	10	50 Hz
1920 x 1080	10	50 Hz
1920 x 1080	10	23.98 / 24 Hz
1920 x 1080	10	25 Hz
1920 x 1080	10	29.97 / 30 Hz

A.3 Control Signal Compatibility

A.3.1 Ethernet Port

Interface	10Base-T/100-Base-TX
Connector	Female RJ-45
Bit Rate	10 Mbps or 100 Mbps half and full duplex

A.3.2 RS232-PIB

Interface	TIA-232
Connector	9-pin subminiature D, female
Bit Rate	115,200 bps
Flow Control	Hardware (RTS/CTS)
Data Format	1 start bit, 8 data bits, 1 stop bit, no parity
Communication Protocol	Christie Serial Protocol

A.3.3 RS232-ICP

Interface	TIA-232
Connector	9-pin subminiature D, female
Bit Rate	38,400 (default), 57,600, 115,200 bps, <u>not</u> auto-detected
Flow Control	Hardware (RTS/CTS)
Data Format	1 start bit, 8 data bits, 1 stop bit, parity odd

A.3.4 GPIO Port

Interface	Opto-LED inputs, TTL voltage output
Connector	37-pin subminiature D, female
Number of I/O Lines	16 - 8 inputs, 8 outputs including 1 health signal output
Type of Connection	Opto-isolated
Input Current	5mA nominal, 50mA maximum
Output Current	50mA maximum
Input Forward Voltage Drop	1.1V nom., 1.4V max. (@5mA)

A.3.5 Simple Contact Closure Interface (SCCI) Port

Interface	Opto-LED inputs, TTL voltage outputs
Connector	9-pin subminiature D, female
Number and type of I/O	Input 1 - Lamp Off Input 2 - Lamp On Input 3 - Douser Open Input 4 - Douser Closed

Input Current	Output 1 - Projector Health (high = health ok) 5mA nominal, 50mA maximum
Input forward voltage drop	1.1V nom., 1.4V max. (@5mA)

A.3.6 3D Port

Interface	Proprietary 3D connector
Connector	15-pin subminiature D, female
Bit Rate	1200 bps
Flow Control	Software
Data Format	1 start bit, 8 data bits, 1 stop bit, no parity
Communication Protocol	RS232 and GPIO

A.3.7 USB 1 Port

Interface	Universal Serial Bus 2.0
Connector	USB Device Standard Sizes (Series “A”)
Maximum Bit Rate	12 Mbps

A.3.8 USB 2 Port

Interface	Universal Serial Bus 2.0
Connector	USB Device Standard Sizes (Series “B”)
Maximum Bit Rate	12 Mbps

A.3.9 MALM (located on Auxiliary Input Panel)

Interface	3.3V CMOS
Connector	9-pin subminiature D, female
Number of I/O Lines	4 GPIO

A.4 Touch Panel Controller

Type of Display	Color VGA TFT LCD, backlit
Display Size	144.8 mm (5.7 inches) diagonal
Display Resolution (H x V pixels)	640 x 480
Maximum Dimensions (W x H x D)	195 mm x 148 mm x 44.4 mm
Integrated Operating System	Microsoft Windows® XPe
Communication Interface with Projector	10/100BaseT Ethernet
Power Requirement	1.02 A maximum at 24VDC ± 10%
Interface Connector	12-pin Circular connector (push-pull)

A.5 Power Requirements

A.5.1 AC Input

Voltage Range	200 - 240 VAC
Line Frequency	50Hz - 60Hz nominal
Inrush Current	45 A maximum (LVPS or LPS)
Current Consumption	23 A maximum (at 200 VAC)
Power Consumption	4500 W maximum
Current Rating of AC Input	30 A maximum (Specified Wall Breaker)

A.5.2 UPS AC Input

Voltage Range	100 - 240 VAC
Line Frequency	50Hz - 60Hz nominal
Inrush Current	50 A maximum
Current Consumption	10 A maximum
Power Consumption	1000 W maximum
Current Rating of AC input	15 A maximum (Specified Wall Breaker)

A.6 Lamp

Type:	Xenon bubble
Power (software adjustable):	
CDXL-20	1000W min., 2000W nom., 2200W max.
CDXL-30	1000W min., 3000W nom., 3100W max.
CDXL-30SD	1000W min., 3000W nom., 3100W max.

NOTES: **1)** The LPS is power regulated. Therefore the maximum power specification for a given lamp may not be achievable until the lamp has aged, since lamp voltage increases with hours of use. **2)** The maximum power of the LPS is restricted to 3000W ± 100W.

Average Life:	
CDXL-20	3500 hours
CDXL-30	2500 hours
CDXL-30SD	2000 hours at 2.5kW / 1100 hours at 3 kW
Wait time between lamp strikes	2 minutes min.
Warm-up time to full brightness	20 minutes max.

NOTE: Hot re-strikes reduce lamp life.

Other lamps with bulb diameters not exceeding 70mm may also be used, however the projector may not meet its specified light output rating. Such lamps include the following:

CXL-30	(3.0kW Xenolite® bulb)
--------	------------------------

A.7 Physical Specifications

Overall Size (L x W x H) <i>(including lens mount, stack and feet)</i>	1097 mm (43.2 inches) x 635 mm (25.0 inches) x 433 mm (17.0 inches)
Weight:	
As installed with lens	111 kg (245 lbs)
Shipping (includes packaging)	143 kg (315 lbs)
Operating Position:	
Rotation about projection axis	± 15 degrees maximum
Tilt of projection axis from horizontal	± 15 degrees maximum

A.8 Regulatory

This product conforms to the following regulations related to product safety, environmental requirements and electromagnetic compatibility (EMC):

A.8.1 Safety

- CAN/CSA C22.2 No. 60950-1
- UL 60950-1
- IEC 60950-1

A.8.2 Electro-Magnetic Compatibility

Emissions

- FCC CFR47, Part 15, Subpart B, Class A - Unintentional Radiators
- CISPR 22:2008-09EN 55022:2006+A1:2007, Class A - Information Technology Equipment

Immunity

CISPR 24:1997 (modified) +A1:2001+A2:2002/EN55024:1998+A1:2001 +A2:2003 EMC Requirements - Information Technology Equipment

Environmental

- EU Directive (2002/95/EC) on the restriction of the uses of certain hazardous substances (RoHS) in electrical and electronic equipment and the applicable official amendment(s)
- EU Directive (2002/96/EC) on waste and electrical and electronic equipment (WEEE) and the applicable official amendment(s)
- EU Directive (2006/121/EC) concerning the Registration, Evaluation, Authorization and Restriction of Chemicals (REACH) and its amendments.
- Japanese industrial standard (JIS C 0950:2005) on marking for the presence of specific chemical substances for electrical and electronic equipment
- China Ministry of Information Industry Order No.39 (02/2006) on the control of pollution caused by electronic information products, hazardous substances concentration limits (SJ/T11363-2006), and the applicable product marking requirements (SJ/T11364-2006)

A.9 Environment

A.9.1 Operating Environment

Temperature	10°C to 35°C (50°F to 95°F)
Humidity (non-condensing)	20% to 80%
Altitude	0 - 3000 meters
Maximum ambient temperature	35°C

A.9.2 Non-Operating Environment

Temperature	-25°C to 65°C (-13°F to 149°F)
Humidity (non-condensing)	0% to 95%

A.10 Accessories

A.10.1 Standard (sold with product)

- Touch Panel Controller (TPC) with interface cable
- User Manual (with CD containing additional technical documentation)
- Interconnect Diagram
- Lens Mount Cover
- Motors and Zoom kit for motorized lens mount
- Light Engine Removal Tool
- Convergence tool

A.10.2 Accessories (sold separately)

- Lenses (prime and auxiliary)

High Brightness Prime Zoom Lenses

- 1.25-1.45 DLPCine HB Zoom Lens (108-274101-01)
- 1.25-1.83 DLPCine HB Zoom Lens (108-342100-01)

- 1.45-2.05 DLPCine HB Zoom Lens (108-335102-01)
- 1.6-2.4 DLPCine HB Zoom Lens (108-336103-01)
- 1.8-3.0 DLPCine HB Zoom Lens (108-337104-01)
- 2.15-3.6 DLPCine HB Zoom Lens (108-338105-01)
- 3.0-4.3 DLPCine HB Zoom Lens (108-278101-01)
- 4.3-6.0 DLPCine HB Zoom Lens (108-279101-01)
- 5.5-8.0 DLPCine HB Zoom Lens (108-280101-01)

High Contrast Prime Zoom Lenses

- 1.25-1.45 DLPCine HC Zoom Lens (38-809079-01)
- 1.45-1.8 DLPCine HC Zoom Lens (38-809061-01)
- 1.8 - 2.4 DLPCine HC Zoom Lens (38-809052-01)
- 2.2-3.0 DLPCine HC Zoom Lens (38-809053-01)
- 3.0-4.3 DLPCine HC Zoom Lens (38-809069-01)
- 4.3-6.1 DLPCine HC Zoom Lens (38-809081-01)
- 5.5-8.5 DLPCine HC Zoom Lens (38-809080-01)

Auxiliary Lenses

- 1.25x Anamorphic Lens (38-809054-01, 38-809054-51)
- 1.26x Wide Converter Lens (108-281101-01)

NOTE: *Use of the Anamorphic or Wide Converter Lens requires the optional Motorized Auxiliary Lens Mount (MALM).*

- Motorized Auxiliary Lens Mount (108-111101-xx & 108-111102-xx)
- Rack Stand (108-282101-02)
- Bracket Foot Lock (116-100101-01)
- Power Plug Cord (116-102104-01)
- High-contrast Internal Aperture Kit (38-813028-51)
- Service documentation
- DLP Cinema® Firmware installation program
- Replacement Lamps
 - 03-000695-01P CDXL-20
 - 03-000696-01P CDXL-30
 - 003-001165-01 CDXL-30SD
- Replacement Air Filters
 - 003-001184-01 Light Engine Filter
 - 003-003082-01 Liquid Cooling Radiator Filter
- Liquid Cooling Kit (003-001837-03)
- TPC Remote Cable (30m) (003-111169-01)

A.10.3 Other Accessories (sold separately)

- IMB
- 3D Equipment

Appendix B: Serial API

This section provides a list of serial API commands that you can run to modify projector settings.

B.1 Function Codes

Auxiliary Motorized Lens (AML)	
Control the motorized auxiliary lens (anamorphic or converter lens). Reset all preference and configuration settings in the device to their default values. The value of 111 must be sent with each of the sub codes as well as the default. The number 111 helps prevent accidental use of this control. Select data packing format for selected input.	
SUBCODE	DESCRIPTION OF USE
CALI*	1, send command to find the center position of the sensor for MALM.
Cxxx	Replace xxx with channel number. Valid range is 101 - 164.
INST	0-1, the flag to indicate if MALM is installed.
LENI*	The number of steps to move MALM to lens in position where (AML1) is set
LENO*	The steps to move MALM to lens out position where (AML0) is set
NONE	Set auxiliary lens position: 0 - lens removed from optical path, 1 - lens inserted in optical path
POSI*	Returns where MALM is located. Read-only command.
<p>* command not applicable on all projectors</p> <p>EXAMPLES:</p> <p>(AML?) Get the current status of auxiliary lens.</p> <p>(AML+C108 1) Use auxiliary lens on channel 108.</p> <p>(AML+C108?) Query auxiliary lens setting for channel 108.</p> <p>(AML+C108!001) Response from previous query.</p> <p>(AML+INST 1) Set flag for using MALM, otherwise MALM is ignored</p> <p>(AML+LENI -300) Move lens to -300 for lens in position</p> <p>(AML+LENO 6000) Move lens to 6000 for lens out position</p> <p>(AML+POSI ?) Query where the lens is</p>	

Automatic Scan Type Detection (ASD)	
Set the Automatic Scan Type Detection ON or OFF for the current channel.	
SUBCODE	DESCRIPTION OF USE
Cxxx	Replace xxx with channel number. Valid range is 101 - 164.
NONE	Select use Automatic Scan Type Detection for the current channel.
<p>EXAMPLES:</p> <p>(ASD?) Get the current status of Automatic Scan Type Detection on the current active channel.</p> <p>(ASD+C108?) Get the current status of Automatic Scan Type Detection on the provided channel.</p> <p>(ASD+C108 1) Use Automatic Scan Type Detection on channel 108.</p> <p>(ASD+C108 0) Do not use Automatic Scan Type Detection on channel 108.</p>	

Baud Rate (BDR)	
Set the baud rate for a serial communications port.	
SUBCODE	DESCRIPTION OF USE
PRTA	Set the baud rate on port A. Rates can be 1200, 2400, 9600, 19200, 38400, 57600, or 115200.
EXAMPLES: (BDR+PRTA6) Set baud rate on port A to 115200 bits per second (BDR+PRTA?) Get baud rate (BDR+PRTA!006 "115200)	

Channel (CHA)	
Select Channel configuration to use. Channel range is 101 to 164. Channel configuration sets the input routing and image processing options for input signals.	
SUBCODE	DESCRIPTION OF USE
NONE	Select Channel. Valid range 101 - 164
EXAMPLES: (CHA?) Get current active channel (CHA 108) Set channel 108 as active channel	

Channel Icon (CHI)	
Set icon file name and path for the specified channel. This selects the icon to be displayed on the Web UI for the channel button.	
SUBCODE	DESCRIPTION OF USE
Cxxx	Replace xxx with the channel number. Valid range is 101 - 164.
NONE	Select icon for the current channel.
EXAMPLES: (CHI+C108 "/etc/data/icons/ch108.ico") Use ch 108.ico for channel 108. (CHI+C108 ?) Get icon file name and path for channel 108. (CHI?L) List all available channel icon entries.	

Color Space (CSP)	
Color space control, color space file will be set when PCF in Use (PIU) is OFF. This control describes the source colorimetry information. Can use index or text string to set control.	
SUBCODE	DESCRIPTION OF USE
Cxxx	Replace xxx with the channel number. Valid range is 101 - 164.
NONE	Select color space for the current channel
EXAMPLES: (CSP+C108 "RGB Unity") Use file "RGB Unity" on channel 108 (CSP+C108?) Get color space file name on channel 108 (CSP?L) List all entries of color space control	

Defaults (DEF)	
This control will reset all preference and configuration settings in the device to their default values. The value of 111 must be sent with each of the sub codes as well as the default. The number 111 helps prevent accidental use of this control. Select data packing format for selected input.	
SUBCODE	DESCRIPTION OF USE
CHAN	Restore default channel settings for specified channel. 0 defaults all channels.
CONF	Restore default configuration settings.
PREF	Restore default preferences.
UNSV	Restore unsaved controls.
USER	Clears all users and restores the factory default user.
NONE	Restore channel, config, preferences, and users.
<p>EXAMPLES:</p> <p>(DEF 111) Restore all preference, configuration, and user controls to default. (DEF+USER 111) Clear all users and restore factory default user (DEF+CONF 111) Reset all configuration controls (DEF+PREF 111) Reset all preference controls (DEF+CHAN 101) Restore Channel 101 (DEF+CHAN 0) Restore all channels</p>	

Data Logging (DLG)	
Set/get the lowest log level to write to the engineering log, also extract data from log in text format. Levels are: 0 = Trace: Level test output, threading info, protocol. 1 = Debug: Debug messages. 2 = Info: Informational messages. 3 = Notices: Event of importance 4 = Warning: Warnings 5 = Error: An error has occurred 6 = Clear: An error has been cleared	
SUBCODE	DESCRIPTION OF USE
NONE	Set/get the minimum log level to write to the log.
EXLG	Extract entries from log files. Requires 3 parameters: "startdate", "enddate", "logtype". The data parameters require the date in the format "yyymmdd". The logtype parameter can have the following values: "ENG" (engineering), "SEC" (security), "OPR" (operational), "MAI" (maintenance), "EVE" (event), "SYS" (system), "ALL".
<p>EXAMPLES:</p> <p>(DLG "20091108" "20091110" "ALL") (DLG+EXLG!"Log data extracted to filename 'logextract.txt' on FTP root") (DLG 2) Set current logging level to 2 (DLG?) Get current logging level. Response is (LDG!00002 "Info")</p>	

Data Format (DTF)	
Select data packing format for selected input. Available data formats depends on current input port (as selected by SIN).	
SUBCODE	DESCRIPTION OF USE
Cxxx	Replace xxx with the channel number. Valid range is 101 - 164.
NONE	Select data format for current channel
EXAMPLES: (DTF?) Get current data format (DTF?L) Show entries on the list (DTF 1) Set current data format to 1 (292: 422 Packed 12Bit) (DTF+C108?) Get data format on channel 108 (DTF+C108 20) Use data format 20 (DVI: Unpacked 8Bit) on channel 108	

Enable Error Messages (EME)	
Enable broadcasting error messages.	
SUBCODE	DESCRIPTION OF USE
FANF	0 - No Fan Fail warning will be generated, 1 - Fan Fail warning will be generated.
NONE	0 - Disable broadcast, 1 - Enable broadcast of error messages to all connected serial ports and telenet sessions.
TEMP	0 - No Over Temperature warning will be generated, 1 - Over Temperature warning will be generated.
EXAMPLES: (EME 1) Enable broadcasting error messages (EME+FANF 0) Disable fan fail alarm warnings (EME?) Requests current state of broadcast. Example response is (EME!001)	

Focus Lens Position Adjustment (FCS)	
Adjust lens to specific focus position with a specified direction. NOTE: <i>This command can only be used to update the current ILS file. Changing the focus for the current channel will change the focus for any channel using the same ILS file.</i>	
Use command without subcode: <ul style="list-style-type: none"> • If ILS is ON, motor will move to specified steps, and save data to the active channel. • If ILS is OFF, motor will move to specified steps. Do not save data to the active channel. 	
SUBCODE	DESCRIPTION OF USE
BACN	Motor backlash in negative direction. Read-only.
BACP	Motor backlash in positive direction. Read-only.
CALB	Calibrate travel range and backlash on specified. Only valid parameter for this command is 1. SET only command.
Cxxx	Replace Cxxx with the channel number. Valid range is 101-164.
NONE	Moving lens mount to a specified vertical position with a specified direction.
RNGN	Motor moving range in negative direction. Read-only.

Focus Lens Position Adjustment (FCS) (Continued)	
RNGP	Motor moving range in positive direction. Read-only.
RSET	Move motor to the center flag then move back to current position. Only valid parameter for this command is 1. SET only command.
STRT	Start motor moving in specified direction, where direction can be (-1, 1). Write-only for v1.3 or newer.
STOP	Stops the motor. Write-only for v1.3 or newer.
MOVR	Moves the motor a given number of steps based on the current location. Write-only for v1.3 or newer.
<p>EXAMPLES: (FCS 500 1) Move lens to position 500 at focus motor with positive approach (FCS 500 -1) Move lens to position 500 at focus motor with negative approach (FCS+C101 -500 1) Set lens focus position for channel 1 to -500 with positive approach (FCS ?) Return current motor position (FCS+CALB 1) Calibrate the focus axis (FCS+RSET 1) Reset the focus axis (FCS+STRT 1) Starts motor moving in positive direction (FCS+STOP) Stops motor (FCS+MOVR -100) Move motor 100 steps in negative direction (FCS+MOVR 200) Move motor 200 steps in positive direction</p>	

Gamma Control (GAM)	
Gamma control, gamma file will be set when PCF in Use (PIU) is off. This control describes the gamma response curve for the source signal.	
SUBCODE	DESCRIPTION OF USE
Cxxx	Replace xxx with the channel number. Valid range is 101 - 164.
NONE	Select gamma for the current channel.
<p>EXAMPLES: (GAM+C108 "gamma 2.6") Use file "gamma 2.6" on channel 108 (GAM+C108?) Get gamma file name on channel 108 (GAM?L) List all entries of gamma control</p>	

Lamp History (HIS)	
<p>Retrieve the history of installed lamp entries, including the current lamp. There is an individual entry for each lamp in the history. The format for each entry is: (HIS!AAA "BBBB/BB/BB" "C" "D" EEE FFF GGG HHH III JJJ KKK).</p> <p>A = Lamp Number B = Date Installed C = Serial Number D = Type E = Strikes F = Failed Strikes G = Failed Restrikes H = Unexpected Lamp Off I = Pre-installed Hours (will always return "00000") J = Lamp Hours K = Lamp Rotation</p>	
SUBCODE	DESCRIPTION OF USE
NONE	None
<p>EXAMPLES: (HIS?) (HIS!000 "N/A" "N/A" "N/A" 000 000 000 000 000 000) (HIS!001 "2007/05/21" "qa-1" "CDXL-30" 000 000 000 000 020 020 001) (HIS!002 "2007/05/21" "qa-2" "Other-30" 000 000 000 000 015 015 000) (HIS!003 "2007/05/21" "qa-3" "Other-20" 000 000 000 000 000 000 001)</p>	

Serial Help (HLP)	
<p>Get help on serial commands.</p>	
SUBCODE	DESCRIPTION OF USE
NONE	Request entire command help listing or list for a single command
<p>EXAMPLES: (HLP?) Retrieve entire command help listing (HLP? "DLG") Retrieve all subcodes/descriptions for DLG control</p>	

ICP File Management (ICP)	
<p>Provides file management for LUT-SCC (PCT), LUT-CLUT, MCGD, TCGD, Source, Screen, and PNG (Test Pattern) files.</p>	
SUBCODE	DESCRIPTION OF USE
FSET	Adds or Copies an ICP file from the TPC's ftproot directory to the appropriate directory on the ICP. Will not overwrite an existing file with the same name.
FGET	Not supported.
FDEL	Deletes a file from the ICP. The filename parameter is case sensitive.

ICP File Management (ICP) (Continued)	
FCOP	Not supported.
FREN	Not supported.
<p>EXAMPLES: (ICP+FSET “ones4K_LE.LUT-SCC”) Copies the “ones4K_LE.LUT-SCC” PCT file from the TPC’s ftproot directory to the LUT-SCC directory on the ICP. (ICP+FSET “Nominal.MCGD”) Copy the “Nominal.MCGD” MCGD file from ftproot to the MCGD directory on the ICP. (ICP+FDEL “Nominal.MCGD”) Deletes the “Nominal.MCGD” file from the ICP.</p>	

ILS File (ILF)	
Set or get the current ILS file for the current or a specific channel.	
SUBCODE	DESCRIPTION OF USE
C1xx	Set or get the current ILS file for a specific channel.
NONE	Select the ILS file for a current channel.
SAVE	Save the currently active ILS data to a file. Will overwrite an existing file with the same name. Requires advanced access level.
FDEL	Delete an ILS File
<p>EXAMPLES: (ILF+C101 “ILS Flat”) Set ILS file for channel 1 to file “ILS Flat” (ILF?L) List all available ILS files (ILF 1) Set ILS file for current channel to index 1 in file list (ILF+Save “filename”) Save the active ILS values to a file named “filename”. If the file doesn’t exist, it will be created. If the file already exists, it will be overwritten. (ILF+FDEL “LensSetup1”) Delete the “LensSetup1” ILS file from the system. (ILF+FDEL 3) Delete the ILS file at index 3 in the list.</p>	

Intelligent Light System Config (ILS)	
Enable/disable the Intelligent Lens System for each channel.	
SUBCODE	DESCRIPTION OF USE
ACLB	Enable/disable the Auto Lens Mount and Lens reset feature. Once ACLB is turned on, lens mount and lens system will be reset automatically when system is powered on.
CALB	Calibrate travel range and backlash on specified. Only valid parameter for this command is 5. SET only command.
CSTS	Motor calibration status (0-100%)
INST	Sets ILS to installed
NONE	Enable/Disable the Intelligent Lens System for each channel. (1/0)

Intelligent Light System Config (ILS) (Continued)	
RSET	Move motor to center flag and then move back to current position. Only valid parameter for this command is 5. SET only command.
RSTS	Motor reset status (0-100%)
<p>EXAMPLES: (ILS 1) Enable ILS, lens will be moved to the position in each channel (ILS 0) Disable ILS, position data in each channel will not be used. Moving lens will not affect any channel setting (ILS+CALB 5) Calibrate all axes of the lens. Set only command (ILS+RSET 5) Reset all axes of the lens (ILS+ACLB 1) Reset lens automatically when power on</p>	

Internal Media Block Installed/Device Type (IMB)	
<p>Access Level: Advanced Min Power Level: Power Down Used to set or query whether an IMB is installed or not. Use the DEVT subcode to set the device type.</p>	
SUBCODE	DESCRIPTION OF USE
DEVT	Set device type from the list of devices.
None	Set or query installed state of IMB.
<p>EXAMPLES: (IMI 1) Set to IMB installed. (IMI+DEVT?L) List valid device types. (IMI+DEVT?) Query current device type.</p>	

Start Interrogator, check interrogator status (INT)	
SUBCODE	DESCRIPTION OF USE
BASC	Start a basic interrogation (set only)
ENHA	Start an enhanced interrogation (set only)
STAT	Responds with 2 values: currently running (1 if running) and result file.
<p>EXAMPLES: (INST+BASC 1) Run a basic interrogation (set only) (INT+STAT?) Query interrogator status. Returns (INT+STAT!00100 00000 "Interrogator_Enhanced_20101103194849.7z"), which means the interrogator is 100% finished, not currently running and the latest interrogator file that was generated is named "Interrogator_Enhanced_20101103194849.7z" and can be found on the projector's FTP server.</p>	

Internal Test Pattern (ITP)	
<p>List and select internal test patterns. This command also creates the customized test pattern list from the internal test patterns. The list of available test patterns is determined by what files are loaded on the TI cinema electronics.</p>	
SUBCODE	DESCRIPTION OF USE
FULL	Set(1)/Reset(0) full screen size
KEEP	When KEEP=1, don't disable test pattern when changing channels
NOCR	NOCR set non-correction test patterns for measured color. Valid range is 0 to 6

Internal Test Pattern (ITP) (Continued)	
NONE	Select test pattern from full list of defined test patterns
STUP	Add test pattern from full list of defined test patterns to the user list
USER	Select test pattern from user defined test pattern list
<p>EXAMPLES: (ITP ?) Get current test pattern, 0 means no test pattern is used. (ITP 4) or (ITP “”) Use number or string to set test pattern (ITP+USER 4) or (ITP+USER “”) Use number or string to set test pattern from user’s test pattern list. (ITP+FULL 1) Use full screen size (ITP+FULL 0) Use active channel screen file (ITP+NOCR 1) Set non-correction test patterns for measured color you can use (ITP+STUP “DC2K Framing Green, DC2K Framing Red”) Add these two test patterns to the user list (ITP+STUP 1 3) Add these two test patterns indexed in the ITP list to the user list</p>	

Lamp Intensity Calibration (LCA)	
<p>This control is used to calibrate (correlate) the intensity feedback mechanism to footlamberts. Note the minimum/maximum power are used to pick two points on the curve. These points will not stay consistent over the life of the lamp, but the conversion algorithm will extrapolate the conversion beyond the range of the two end points. Footlamberts for minimum/maximum power are converted to integer by multiplying 100 because serial command protocol does not support floating point number. NOTE: <i>Changing the lamp or lamp alignment will require re-calibration.</i></p>	
SUBCODE	DESCRIPTION OF USE
MAXF	Set footlamberts at maximum lamp power, the value should be (footlamberts * 100)
MAXS	Set sensor value at maximum lamp power
MINF	Set footlamberts at minimum lamp power, the value should be (footlamberts * 100)
MINS	Set sensor value at minimum lamp power
NONE	Not available
<p>EXAMPLES: (LCA+MINF 10) Set 10 footlamberts as measured brightness at minimum lamp power (LCA+MINF?) Get footlamberts on minimum lamp power (LCA+MINS 5000) Set 5000 as reading value from the light sensor at minimum lamp power (LCA+MAXF 17) Set 17 footlamberts as measured brightness as maximum lamp power (LCA+MAXF?) Get footlamberts at maximum lamp power (LCA+MAXS 15000) Set 15000 as reading value from the light sensor on maximum lamp power</p>	

LUT CLUT Control (LCT)	
<p>Set Look up Table (LUT) Color Look Up Table (CLUT) file for the specified channel. The CLUT is used during color processing in the cinema electronics.</p>	
SUBCODE	DESCRIPTION OF USE

LUT CLUT Control (LCT) (Continued)	
Cxxx	Replace xxx with the channel number. Valid range is 101 - 164.
NONE	Select CUT for the current channel.
<p>EXAMPLES: (LCT+C108 "9x9x9") Use PCF file "9x9x9" on channel 108 (LCT+C108?) Get LUT-CLUT file name on channel 108 (LCT?L) List all entries of LUT-CLUT control</p>	

Link Decrypter Bypass (LDB)	
Setting LD bypass to TRUE (1) will bypass the link decrypter (LD). Only use if marriage is broken and content being played is not CineLink 2 encrypted (non D-Cinema content).	
SUBCODE	DESCRIPTION OF USE
Cxxx	Replace xxx with the channel number. Valid range is 101 - 164.
NONE	Set to 1 to bypass and 0 to not bypass.
<p>EXAMPLES: (LDB+C108 1) Bypass link decrypter on channel 108. (LCT 0) Use link decrypter on current channel (i.e. do not bypass). (LCT+C108?) Get value for LDB on channel 108.</p>	

Link Decrypter Installed (LDI)	
<p>Access Level: Advanced Min Power Level: Power Down Set LD to installed or not installed.</p>	
SUBCODE	DESCRIPTION OF USE
None	Set to 1 to installed and 0 to not installed.
<p>EXAMPLES: (LDI 1) Set LD installed.</p>	

Lamp Intensity Calibration (LEN)	
Define model and serial number for primary installed lens and auxiliary lens.	
SUBCODE	DESCRIPTION OF USE
AMOD	Auxiliary lens model
ASER	Auxiliary lens serial number
MMOD	Main lens model

Lamp Intensity Calibration (LEN) (Continued)	
MSER	Main lens serial number
NONE	Not available
<p>EXAMPLES: (LEN+MMOD?L) List supported lens model (LEN+AMOD?L) List supported auxiliary lens model (LEN+MMOD 1 Set lens model (LEN+MSER “xxxx”) Set lens serial number</p>	

Lens Horizontal Position Adjustment (LHO)	
<p>Adjust lens offset to specific horizontal position with a specified direction. NOTE: <i>This command can only be used to update the current ILS file. Changing the horizontal offset for the current channel will change the horizontal offset for any channel using the same ILS file.</i></p> <p>Use command without subcode:</p> <ul style="list-style-type: none"> • If ILS is ON, motor will move to specified steps and save data to the active channel. • If ILS is OFF, motor will move to specified steps, do not save data to the active channel. 	
SUBCODE	DESCRIPTION OF USE
BACN	Motor backlash in negative direction. Read-only.
BACP	Motor backlash in positive direction. Read-only.
CALB	Calibrate travel range and backlash on specified. Only valid parameter for this command is 1. Set only command.
Cxxx	Replace xxx with the channel number. Valid range is 101-164.
NONE	Moving lens mount to a specified horizontal position with a specified direction.
RNGN	Motor moving range in negative direction. Read-only.
RNGP	Motor moving range in positive direction. Read-only.
RSET	Move motor to the center flag then move back to current position. Only valid parameter for this command is 1. Set only command
STRT	Start motor moving in specified direction, where direction can be (-1, 1). Write-only for v1.3 or newer.
STOP	Stops the motor. Write-only for v1.3 or newer.
MOVR	Moves the motor a given number of steps based on the current location. Write-only for v1.3 or newer.
<p>EXAMPLES: (LHO 500 1) Move lens to position 500 along horizontal axis with positive approach (LHO 500 -1) Move lens to position 500 along horizontal axis with negative approach (LHO+C101 -500 1) Set lens horizontal position for channel 1 to -500 with positive approach (LHO ?) Return current motor position along horizontal axis and direction (-1 or 1) (LHO+CALB 1) Calibrate the horizontal axis (LHO+RSET 1) Reset the horizontal axis (LHO+STRT 1) Starts motor moving in positive direction (LHO+STOP) Stops motor (LHO+MOVR -100) Move motor 100 steps in negative direction (LHO+MOVR 200) Move motor 200 steps in positive direction</p>	

Lamp ID (Type) (LID)	
Get lamp type (ID) for the currently installed lamp. Supports readback of the list of supported lamp types.	
SUBCODE	DESCRIPTION OF USE
NONE	Get Lamp ID for current lamp. This is a read-only control. Lamp ID can be changed with LPC (lamp change) command only.
<p>EXAMPLES:</p> <p>(LID?L) List supported lamp IDs</p> <p>(LID?) Get the lamp ID for installed lamp</p>	

LampLOC™ Module (LLM)	
Allows adjustment of lamp position to optimize intensity and uniformity of the optical system. This is referred to as the LampLOC™ feature and can be done automatically or manually.	
SUBCODE	DESCRIPTION OF USE
AUTO	Set to 1 to do LampLOC™ automatically. It will do calibration first, then move the X, Y, Z-motors to find the maximum brightness. Set to 0 to cancel auto adjustment and restore the previous position. Reset to 0 when it has finished.
CALI	Calibrate LampLOC motors.
MTRX	Moving X-axis motor manually. Data range from ±250.
MTRY	Moving Y-axis motor manually. Data range from ±250.
MTRZ	Moving Z-axis motor manually. Data range from ±175.
NONE	Not Available
STAT	Provides feedback (status) on the progress of the Auto mode. Read-only command. Data range from 0 to 100, where 100 indicates the LampLOC™ is finished.
<p>EXAMPLES:</p> <p>(LLM+MTRX 100) Move motor X to position 100</p> <p>(LLM+AUTO 1) Do LampLOC™ automatically</p> <p>(LLM+AUTO 0) Abort LampLOC™. It will restore the motors to previous position automatically</p> <p>(LLM+AUTO?) Get running status. (LLM+AUTO!000) indicates finished, (LLM+AUTO!001) indicates running</p> <p>(LLM+STAT ?) Get the progress feedback of the Auto mode (0-100%)</p>	

Adjust All Lens Position Parameters Simultaneously (LMV)	
Adjust all lens position parameters simultaneously.	
SUBCODE	DESCRIPTION OF USE
NONE	(LMV <lho><lvo><zom><fcs><lhodir><lvodir><zomdir><fcsdir>) where <lhodir>, <lvodir>, <zomdir>, and <fcsdir> represent the horizontal, vertical, zoom, and focus position information. Valid values for direction are 1 and -1.
<p>EXAMPLES:</p> <p>(LMV 1000 1500 500 -500 -1 -1 1 1)</p>	

Local Settings (LOC)	
Set the time format and display options for temperature units.	
SUBCODE	DESCRIPTION OF USE
LANG	Set the current language of the user interface.
TEMP	Set the temperature units. 0 - Celsius. 1 - Fahrenheit.
TIME	Set Time format. 0 - 24 hour, 1 - 12 hour.
EXAMPLES: (LOC+TIME 1) Set time zone to standard 12 hour (LOC+TIME?1) Get list of formats (LOC+TIME?)(LOC+TIME!001) Get time format	

Lamp Changed (LPC)	
Record current lamp information into the lamp history, then start a new entry. Set lamp information of a new lamp type ID, serial number, and pre-used hours. When the values are set, use the (LPC 1) command to add the record.	
SUBCODE	DESCRIPTION OF USE
LPID	Set lamp type ID for the new lamp
NONE	Save lamp information to lamp history
PREV	Set lamp previous lamp hours for the new lamp
SERL	Set lamp serial number for the new lamp
EXAMPLES: (LPC+LPID 2) Set lamp type ID (LPC+SERL "CDX30-001") Set lamp serial number (LPC 1) Save information to lamp history. Consecutive lamp changes require a 5 - 10 second time difference as writing to EEPROM is involved.	

Lamp File (LPF)	
Set or get the current lamp file for the current or a specific channel. This command can also be used to save the active lamp data to a new or existing lamp file, and delete a lamp file from the system.	
SUBCODE	DESCRIPTION OF USE
Cxxx	Set or get the current lamp file for a specific channel
NONE	Set lamp file for current channel
SAVE	Save the currently active lamp data to a file. Will overwrite an existing file with the same name.
FDEL	Delete a lamp file from the system.
EXAMPLES: (LPF+C101 "Default") Set lamp file for channel 1 to file "Default" (LPF?L) List all available lamp files (LPF 1) Set lamp file for current channel to index 1 in file list (LPF+SAVE "filename") If the file doesn't exist, it will be created. If the file already exists, it will be overwritten. (ILF+FDEL "LampSetup1") Delete the "LampSetup1" lamp file from the system. (ILF+FDEL 3) Delete the lamp file at index 3 in the list.	

Lamp Hours (LPH)	
Get information on installed lamp. Read only control.	
SUBCODE	DESCRIPTION OF USE
FLSK	Return total failed lamp strikes on the installed lamp
FRSK	Return total failed lamp restrikes on the installed lamp
LPOF	Return total lamp unexpected off times on the installed lamp
NONE	Return lamp usage for current lamp in hours.
TL SK	Return total lamp strikes on the installed lamp
<p>EXAMPLES: (LPH?) Get usage in hours (LPH+FLSK?) Get lamp strikes</p>	

Lamp Intensity (LPI)	
<p>Set lamp intensity setpoint. The value is used when lamp mode is set to LiteLOC™. The projector will adjust the Lamp Power to maintain this intensity. NOTE: <i>This command can only be used to update the current lamp file. Changing the lamp intensity for the current channel will change the lamp intensity for any channel using the same lamp file.</i></p>	
SUBCODE	DESCRIPTION OF USE
Cxxx	Replace Cxxx with the channel number. Valid range is 101-164.
NONE	Set lamp intensity for the current channel.
<p>EXAMPLES: (LPI 4500) Set lamp intensity to 4500 for current channel (LPI+C103 4000) Set the lamp intensity to 4000 for channel 3 (LPI?) Get lamp intensity for the active channel</p>	

Lamp Life (LPL)	
<p>Set/get expected lamp life in hours. The default hours will be used if lamp life is ‘not set’. Lamp expiry message will be sent out when lamp usage is over the lamp life.</p>	
SUBCODE	DESCRIPTION OF USE
LIFE	0 - No warning will be generated. 1 - Lamp Life Expiry Warning will be generated when lamp hours extends past lamp life. Warning will be reported in SST. Warning will be cleared by extending lamp life or changing the lamp.
NONE	Set or get expected lamp life.

Lamp Life (LPL) (Continued)	
ROTA	Set to 1 acknowledge the Lamp Rotation Warning. Will auto clear at lamp life or on lamp change.
ROTW	0 - No warning will be generated. 1 - Lamp Rotation Warning will be generated when lamp hours extends past 1/2 lamp life. Warning will be reported in SST. Warning will be cleared by LPL+ROTA or changing the lamp.
<p>EXAMPLES: (LPL 1500) Set lamp life limit to 500 hours. (LPL 0) Set lamp life limit to default hours based on the lamp type. (LPL ?) Get lamp life limit. (LPL+LIFE 1) Enable lamp expired message. (LPL+LIFE 0) Disable lamp expired message. (LPL+ROTW 1) Enable lamp rotation message. (LPL+ROTA 1) Acknowledge that lamp was rotated.</p>	

Lamp Mode (LPM)	
Set lamp mode to constant power or LiteLOC™ for global and per channel. NOTE: <i>This command can only be used to update the current lamp file. Changing the lamp power for the current channel will change the lamp power for any channel using the same lamp file.</i>	
SUBCODE	DESCRIPTION OF USE
Cxxx	Replace Cxxx with the channel number. Valid range is 101-164.
NONE	Set lamp mode for the current channel.
<p>EXAMPLES: (LPM 0) Set Constant Power mode for current channel (LPM "Constant Power") Set Constant Power mode for active channel (LPM+C101 1) Set intensity mode for channel 1 (LPM?) Get Lamp mode for active channel</p>	

Lamp Power (LPP)	
Set lamp power to be used when in Constant Power mode. NOTE: <i>This command can only be used to update the current lamp file. Changing the lamp power for the current channel will change the lamp power for any channel using the same lamp file.</i>	
SUBCODE	DESCRIPTION OF USE
Cxxx	Replace Cxxx with the channel number. Valid range is 101-164.
MINI	Get nominal minimum lamp power for the current lamp. Read-only value
NONE	Set lamp power for the current channel.
<p>EXAMPLES: (LPP 2500) Set lamp power to 2500 for current channel (LPP+C102 2000) Set lamp power to 2000 for channel 2 (LPP+C102?) Get the lamp power for channel 2</p>	

Lens Vertical Offset Adjustment (LVO)	
Adjust lens offset to specific vertical position with a specific direction. NOTE: <i>This command can only be used to update the current ILS file. Changing the vertical offset for the current channel will change the vertical offset for any channel using the same ILS file.</i>	
Use command without subcode: <ul style="list-style-type: none"> • If ILS is ON, motor will move to specified steps and save data to the active channel. • If ILS is OFF, motor will move to specified steps. Do not save data to the active channel. 	
SUBCODE	DESCRIPTION OF USE
BACN	Motor backlash in negative direction. Read-only.
BACP	Motor backlash in positive direction. Read-only. Set only command.
CALB	Calibrate travel range and backlash on specified. Only valid parameter for this command is 1. Set only command.
Cxxx	Replace Cxxx with the channel number. Valid range is 101-164.
NONE	Moving lens mount to a specified vertical position with a specified direction.
RNGN	Motor moving range in negative direction. Read-only.
RNGP	Motor moving range in positive direction. Read-only.
RSET	Move motor to the center flag then move back to current position. Only valid parameter for this command is 1. Set only command.
STRT	Start motor moving in specified direction, where direction can be (-1, 1). Write-only for v1.3 or newer.
STOP	Stops the motor. Write-only for v1.3 or newer.
MOVR	Moves the motor a given number of steps based on the current location. Write-only for v1.3 or newer.
EXAMPLES: (LVO 500 1) Move lens to position 500 along vertical axis with positive approach (LVO 500 -1) Move lens to position 500 along vertical axis with negative approach (LVO+C101 -500 1) Set lens vertical position for channel 1 to -500 with positive approach (LVO ?) Return current motor position along vertical axis and direction (LVO+CALB 1) Calibrate the vertical axis (LVO+RSET 1) Reset the vertical axis (LVO+STRT 1) Starts motor moving in positive direction (LVO+STOP) Stops motor (LVO+MOVR -100) Move motor 100 steps in negative direction (LVO+MOVR 200) Move motor 200 steps in positive direction	

Measured Color (MCG)	
Select the Measured Color Gamut file. This file describes the native colorimetry for the projector as installed and is required for accurate color processing in the cinema electronics. This control is per channel to allow for different colorimetry for applications such as 3D.	
SUBCODE	DESCRIPTION OF USE
Cxxx	Replace xxx with the channel number. Valid range is 101 - 164.
NONE	Select measured color gamut for the current channel.

Measured Color (MCG) (Continued)	
DATA	Set/Get active MCGD measurement values. The order is RedX, RedY, GreenX, GreenY, BlueX, BlueY, WhiteX, WhiteY, BlackX, BlackY. The range for each value is 0 - 100000. The values represent MCGD measurement values multiplied by 100000.
SAVE	Saves the active MCGD measurement values to a new or existing MCGD file. (SET Only Command)
<p>EXAMPLES: (MCG+C108 "Nominal") Use file "Nominal" on channel 108 (MCG+C108?) Get measured color file name on channel 108 (MCG?L) List all entries of measured color control (MCG+DATA 123 31786 00333 0 100000 66000 1 88899 2154 5441) Set the active MCGD measurement values to RedX=0.00123, RedY=0.31786, GreenX=0.00333, GreenY=0.00000, BlueX=1.00000, BlueY= 0.66000, WhiteX=0.00001, WhiteY=0.88899, BlackX=0.02154, BlackY=0.05441 (MCG+DATA?) Retrieve the 10 active MCGD measurement values. (MCG+SAVE "filename") Save the 10 active MCGD measurement values to a file named "filename". If the file doesn't exist, it will be created. If the file already exists, it will be overwritten.</p>	

Monitor Card Cage Fans (MCF)	
Enables or disables the monitoring of the two additional card cage fans.	
SUBCODE	DESCRIPTION OF USE
NONE	Set to 1 to monitor and 0 to not monitor.
<p>EXAMPLES: (MCF 1) Start monitoring the card cage fans</p>	

Channel Name (NAM)	
Set the descriptive channel name for the specified channel	
SUBCODE	DESCRIPTION OF USE
Cxxx	Replace xxx with the channel number. Valid range is 101 - 164.
NONE	Select channel name for the current channel.
<p>EXAMPLES: (NAM+C108 "Scope 2.39") Set channel name for channel 108 (NAM+C108?) Get channel name for channel 108</p>	

Network Setup (NET)	
Set the network parameters for Eth0, Gateway, and Subnet 0.	
SUBCODE	DESCRIPTION OF USE
DLP0	Set the IP address for the MGMT Ethernet controller (deprecated).
ETH0	Set the WAN IP address for the projector
GATE	Set the WAN Gateway for the projector
HOST	Host name

Network Setup (NET) (Continued)	
MAC0	Gets the MAC address of the projector
SUB0	Set the WAN subnet mask for the projector
<p>EXAMPLES: (NET+ETH0 "192.168.1.35") Set new IP address on the MGMT Ethernet controller (NET+GATE "192.168.0.1") Set the gateway (NET+SUB0 "255.255.255.0") Set the subnet mask on the MGMT Ethernet controller (NET+HOST "MyHostName") Set the host name (NET+ETH0 ?) Retrieve IP address from the MGMT Ethernet controller. (NET+ETH0! 192.168.1.35) (NET+MAC0 ?) Retrieve MAC address from MGMT controller. (NET+MAC0! 00:12:3F:7B:76:B4) (NET+GATE ?) Retrieve default gateway. (NET+GATE! 192.168.0.1) (NET+DLP0 "192.168.206.10") Set IP address (deprecated) (NET+DLP0?) (NET+DLP0! "192.168.206.10") Query IP address (deprecated)</p>	

Projector Configuration File (PCF)	
Set Projector Configuration File (PCF) file for the specified channel. This file is used to configure many aspects of the cinema electronics. It will only be used if PCF in use (PIU) control is set.	
SUBCODE	DESCRIPTION OF USE
Cxxx	Replace xxx with the channel number. Valid range is 101 - 164.
NONE	Select PCF file for the current channel
<p>EXAMPLES: (PCF+C108 "SCOPE 2.39") Use PCF file "Scope 2.39" on channel 108. File used when PIU is on (PCF?L) List all entries of PCF control</p>	

PCF In Use (PIU)	
Select whether to use the PCF file or not.	
SUBCODE	DESCRIPTION OF USE
Cxxx	Replace xxx with the channel number. Valid range is 101 - 164.
NONE	Select "Use PCF" for the current channel
<p>EXAMPLES: (PIU?) Get the current status of PCF file (PIU+C108 1) Use PCF file on channel 108 (PIU+C108 0) Do not use PCF file on channel 108</p>	

Ping (PNG)	
<p>This command returns basic projector information to the user which includes the type of device & main software version. Note that some devices have multiple CPUs each with its own software version. Only the software version of what is considered to be the master CPU is returned here. The return parameters are: Type, Major, Minor, and Beta. The beta value is optional meaning it is an engineering build and has not been validated. NOTE: <i>List of devices:</i> 40 = ACT, 41 = CP2000-ZX, 42 = CP2000-M, 46 = CP4230/CP4230/CP4230, 48 = MCB/IMCB, 49 = EVB</p>	
SUBCODE	DESCRIPTION OF USE
NONE	None
<p>EXAMPLES: (PNG?)(PNG!46 001 000 234) -- Indicates 'Cinema' type, software: 1 major, 0 minor, 234 beta</p>	

Power (PWR)	
<p>Change the power state of the projector. Data can be: 3 - Power OFF - all electronics power OFF except Projector Control Module (PCM). It's also called Standby mode. 1 - Power ON - projector is powered ON with lamp ON. 0 - Full power mode - projector is ready for lamp ON. 11 - Warm up. Read only, it's middle status between standby and full power mode. 10 - Cool down. Read only, projector will stay in cooling down mode for 15 minute after lamp is turned OFF.</p>	
SUBCODE	DESCRIPTION OF USE
COOL	Status of current cooling down timer. Read only command.
NONE	Select power state.
STAT	Status of current power state. Read only command.
<p>EXAMPLES: (PWR+STAT?) - Get projector power status (PWR+COOL?) - Get how many seconds left on cooling down mode (PWR3) - Set the projector to standby mode (PWR0) - Turn the projector ON and lamp OFF (PWR1) - Turn the projector ON and lamp ON (PWR?) - Get the target power state from the latest command sent to the projector. Target power state. For projector power states, refer to Table 3.1.</p>	

Remote Access Level (RAL)	
<p>Set the remote serial protocol access level for a serial communications port. Valid sections are 0 - No Access, 1 - Login Required, 2 - Free Access. Default value is 1 - Login required.</p>	
SUBCODE	DESCRIPTION OF USE

Remote Access Level (RAL) (Continued)	
NONE	Set the access level on Ethernet all ports.
PRTA	Set the access level on RS232 port A.
EXAMPLES: (RAL 0) Disable remote serial protocol access for all Ethernet ports (RAL?) Get access level for Ethernet ports (RAL!0) (RAL+PRTA 2) Set remote serial protocol access level on port A to free access (RAL+PRTA?) Get access level (RAL+PRTA!2)	

Reboot TPC (RBT)	
Command for rebooting the TPC, requires argument 3.	
SUBCODE	DESCRIPTION OF USE
NONE	Reboot TPC, use 3 as argument other arguments have no effect.

Schedule (SCH)	
Schedule a power up or a power down at a specific time.	
SUBCODE	DESCRIPTION OF USE
BPON	Bypass power on scheduling. 1 = enable, 0 = disable
BPOF	Bypass power off scheduling. 1 = enable, 0 = disable
POND	Set the power on date and time, setting the date/time to empty (""") will turn off power on scheduling until a new date/time has been set. Format "yyyy-mm-dd hh:mm"
POFD	Set the power off date and time, setting the date/time to empty (""") will turn off power off scheduling until a new date/time has been set. Format "yyyy-mm-dd hh:mm"
EXAMPLES: (SC+BPON 1) Disable power on scheduling events, it will still be possible to set the time but no event will occur. (SC+POFD "2011-07-11 23:00") Schedule a power off event at 11pm on 11 July, 2011 (SC+POND "") Set the power on event to no time - no event will be scheduled, if one was scheduled before it is removed. (SC+BPOF?) Query the current setting for bypass power off events.	

Screen Format (SCF)	
Select Screen format file which describes the geometry for the output image.	
SUBCODE	DESCRIPTION OF USE
Cxxx	Replace xxx with the channel number. Valid range is 101 - 164.
NONE	Select screen file for the current channel.
EXAMPLES: (SCF+C108 "FLAT") Use file "FLAT" on channel 108 (SCF+C108?) Get screen file name on channel 108 (SCF?L) List all available entries of screen control	

Shutter/Douser (SHU)	
Open/Close shutter/douser	
SUBCODE	DESCRIPTION OF USE
NONE	Select douser position 0 - douser removed from optical path 1 - douser blocking optical path
STEP	The number of steps the douser should be moved when opening/closing (default 60, minimum 30, maximum 200)
EXAMPLES: (SHU 1) Close shutter (SHU 0) Open shutter (SHU?) Get current status of shutter (SHU+STEP?) Get number of steps douser should move to open/close	

Select Input (SIN)	
Selecting input port will reset the list and default data of DTF control. Use index number or text description to select input port. Available options are: "Auto-select", "292-A", "292-B", "292-Dual", "DVI-A", "DVI-B", "DVI-Dual/Twin"	
SUBCODE	DESCRIPTION OF USE
Cxxx	Replace xxx with the channel number. Valid range is 101 - 164.
NONE	Select input for current channel
EXAMPLES: (SIN?) Get current input port (SIN?L) Show entries on the list (SIN 1) Set current input port to entry with index 1 (SIN+C101 ?) Get input port on channel 101 (SIN+C101 1) Set input on channel 101	

SNMP Agent Configuration (SNM)	
This control will set the various configuration options for SNMP Agent	
SUBCODE	DESCRIPTION OF USE
ENVT	Enables/Disables SNMP version 2 and enables version 3
LEXT	Gets/sets the Lamp Expire Trap Flag for the SNMP Agent

SNMP Agent Configuration (SNM) (Continued)	
LHLT	Gets/sets the Lamp Half Life Trap Flag for the SNMP Agent
TSIP	Sets the Trap IP address for the SNMP agent
<p>EXAMPLES: (SNM+TSIP “xxx.xxx.xxx.xxx”) Sets the Trap IP address to xxx.xxx.xxx.xxx (SNM+TSIP “0.0.0.0”) Setting the IP address to 0.0.0.0 will stop SNMP Agent from sending the traps. (SNM+LHLT 1) Setting this flag to 1 will disable any future lamp half life traps (SNM+LEXT 1) Setting this flag to 1 will disable any future lamp expire traps (SNM+ENVT ?) Get the flag to see if V2 is enabled (1) or disabled (0) (SNM+ENVT 1) Enable SNMP V2 (SNM+ENVT 0) Disable SNMP V2</p>	

Screen Orientation (SOR)	
Set screen orientation. This allows for flipping the screen orientation to allow for various mounting options of the projector including the use of mirrors and front or rear screen projection.	
SUBCODE	DESCRIPTION OF USE
NONE	Select Orientation: 0 - Normal Front, 1 - Inverted Rear, 2 - Normal Rear, 3- Inverted Front
<p>EXAMPLES: (SOR?L) List orientation options (SOR?) Get the orientation status (SOR0) Set orientation to front</p>	

Select Source Format (SRF)	
Select the Source format file.	
SUBCODE	DESCRIPTION OF USE
Cxxx	Replace xxx with the channel number. Valid range is 101 - 164.
NONE	Select source format for the current channel.
<p>EXAMPLES: (SRF+C108 “XXX”) Use file “XXX” on channel 108 (SRF+C108?) Get source file name on channel 108 (SRF?L) List all entries of source control (SRF+RFSH 1) Refresh TI file list</p>	

System Status (SST)	
Retrieve the various system status groups.	
SUBCODE	DESCRIPTION OF USE
ALRM	Returns a summary of any active alarms
CONF	Returns configuration data - model, sn, build date, etc

System Status (SST) (Continued)	
COOL	Returns cooling data - cooling fans, air flow, etc
HLTH	Returns system health
INTE	Returns interlock data
LAMP	Returns lamp operational data.
NONE	Returns information on all status groups, with one message per item.
PERI	Returns peripherals data - Cine-IPM, etc
SECU	Returns security data
SERI	Return serial numbers
SIGN	Returns signal data - freq, etc.
SYST	Returns system data - power, hours of use, shutter open, etc
TEMP	Returns temperature data
VERS	Returns version numbers
<p>EXAMPLE: (SST+ALRM?) returns (SST+ALRM!000 002 “101” “Prism temperature”) where parameters are: P1=index number, P2=error level, P3=value, P4=description.</p> <p>Error level is: 0=no errors or warnings, 1=warning, 2=error, 3=error and warning</p>	

Stop DLP Communication (STP)	
Stop communications to DLP® Cinema Electronics temporarily, i.e. for DLP software upgrading.	
SUBCODE	DESCRIPTION OF USE
NONE	0 - restart DLP communications; 1 - stop DLP communications.
<p>EXAMPLES: (STP 0) Restart DLP communication (STP 1) Stop DLP communication (STP?) Request current state. Example response is (STP!000)</p>	

Projector Platform and Motherboard Related Information (SYS)	
Query only command that returns version information.	
SUBCODE	DESCRIPTION OF USE
BACB	Return backplane version information.

Projector Platform and Motherboard Related Information (SYS) (Continued)	
FACB	Return faceplate version information.
PIBB	Return PIB version information.
EXAMPLES: (SYS+BACB?) Returns backplane version information.	

Target Color Gamut (TCG)	
Set the Target Color Gamut file. This file describes desired output colorimetry from the projector. For this control to function the Measured Color Gamut Data must be accurate.	
SUBCODE	DESCRIPTION OF USE
Cxxx	Replace xxx with the channel number. Valid range is 101 - 164.
NONE	Select target color gamut for the current channel.
EXAMPLES: (TCG+C108 "Atlantis") Use file "Atlantis" on channel 108 (TCG+C108?) Get target color file name on channel 108 (TCG?L) List all available entries of target color control	

Enable 3D (TDC)	
Enable/disable 3D on the specified channel or the current channel. This controls the frame rate multiplication features that allow for simulated three dimensional image projection.	
SUBCODE	DESCRIPTION OF USE
Cxxx	Replace xxx with the channel number. Valid range is 101 - 164.
NONE	Select 3D enable for the current channel
EXAMPLES: (TDC+C108 1) Enable 3D on channel 108 (TDC+C108?) Get 3D setting on channel 108 (TDC?) Get current 3D status	

3D DARK TIME (TDK)	
Set dark time_for 3D control. This controls how much time between displayed images the output remains dark to allow for the glasses on other gating mechanism to flip between the eyes.	
SUBCODE	DESCRIPTION OF USE
Cxxx	Replace xxx with the channel number. Valid range is 101 - 164.
NONE	Select dark time for the current channel
EXAMPLES: (TDK+C101 1) Set dark time to 1 on channel 101 (TDK+C101?) Get dark time on channel 101	

Output Reference Delay (phase) (TDP)	
Set output reference delay phase for 3D control. This is an additional control for output timing relative to input timing. The data range is -180 to 180.	
SUBCODE	DESCRIPTION OF USE
Cxxx	Replace xxx with the channel number. Valid range is 101 - 164.
NONE	Select output reference delay phase for the current channel
EXAMPLES: (TDP+C101 1) Set output reference delay phase to 1 on channel 101 (TDP+C101?) Get output reference delay phase on channel 101	

3D L/R Display Reference (TDR)	
Set the L/R display reference for 3D control.	
SUBCODE	DESCRIPTION OF USE
Cxxx	Replace xxx with the channel number. Valid range is 101 - 164.
NONE	Select L/R display reference for the current channel
EXAMPLES: (TDR+C101 1) Set L/R display reference to 1 on channel 101 (TDR+C101?) Get L/R display reference on channel 101	

Output Reference Delay (time) (TDT)	
Set output reference delay time for 3D control. This command controls how much delay between the input and output reference timing.	
SUBCODE	DESCRIPTION OF USE
Cxxx	Replace xxx with the channel number. Valid range is 101 - 164.
NONE	Select reference delay for the current channel
EXAMPLES: (TDT+C101 1) Set output reference delay time to 1 on channel 101 (TDT+C101?) Get output reference delay time on channel 101	

L/R Display Sequence (TFD)	
Set L/R Display Sequence for 3D control. This selects which signal is considered first in the source signal, the left or the right.	
SUBCODE	DESCRIPTION OF USE
Cxxx	Replace xxx with the channel number. Valid range is 101 - 164.
NONE	Select L/R display sequence for the current channel
EXAMPLES: (TFD?L) List all entries on Input Frame Dominance control (TFD+C101 1) Set Input Frame Dominance to 1 on channel 101 (TFD+C101?) Get Input Frame Dominance on channel 101	

3D Frame Rate Multiple (TFR)	
Setup frame rate multiple for 3D control	
SUBCODE	DESCRIPTION OF USE
Cxxx	Replace xxx with the channel number. Valid range is 101 - 164.
NONE	Select 3D frame rate for the current channel.
EXAMPLES: (TFR?L) List all entries on the frame rate multiple factor (TFR+C101 3) Set frame rate multiple to “4:2” on channel 101 (TFR+C101?) Get frame rate multiple on channel 101	

Get Certificates (TIG)	
Gets the LD or ICP certificate.	
SUBCODE	DESCRIPTION OF USE
ENGC	Retrieve LD Certificate
ICPC	Retrieve ICP Certificate
EXAMPLES: (TIG+ENGC?) Gets the LD certificate (TIG+ICPC?) Gets the ICP certificate	

3D Input Reference (TIR)	
Setup the Input Reference for 3D control.	
SUBCODE	DESCRIPTION OF USE
Cxxx	Replace xxx with the channel number. Valid range is 101-164.
NONE	Select input reference for the current channel.
EXAMPLES: (TDK+C101 “Use GPI (polarity=true)”) set Input Reference to ‘Use GPI (polarity=true)’ on channel 101 (TDK+C101?) get Input Reference for channel 101	

Time/Date (TMD)	
Set/get the time, date and time zone.	
SUBCODE	DESCRIPTION OF USE
DATE	Get the date in the form yyyy/mm/dd. Read-only.
DSTA	Set/get the daylight savings time adjust value.
TIME	Set/get the local time in the form hh:mm:ss. Ready only.

Time/Date (TMD) (Continued)	
TOFF	Set Time Offset in seconds (± 900 seconds). Must be powered ON. (Write-only)
ZONE	Set/get the time zone
<p>EXAMPLES: (TMD+DSTA?) 0 or 1 (DST OFF or DST ON) (TMD+DSTA 0) Turn daylight savings OFF (0) or ON (1) (TMD+ZONE 20) Set time zone to EST (TMD+TIME?) Get local time (TMD+TIME! 17:50:45) (TMD+TOFF 120) Increase the time by two minutes. (“TMD+TOFF: Disabled Control”) Error message returned when power is OFF. (“TMD+TOFF: LD Real Time Clock Offset range for time adjustment has been exceeded.”)</p>	

3D Output Reference Polarity (TOP)	
Setup output timing signal reference polarity for 3D control.	
SUBCODE	DESCRIPTION OF USE
Cxxx	Replace xxx with the channel number. Valid range is 101-164.
NONE	Select output reference polarity for the current channel.
<p>EXAMPLES: (TOP+C101 1) Set Output Reference Polarity to 1 on channel 101 (TOP+C101?) Get Output Reference Polarity on channel 101</p>	

User ID (UID)	
Allows users to login to the serial interface.	
SUBCODE	DESCRIPTION OF USE
NONE	None
<p>EXAMPLES: (UID) “username” “password”) Login a user (UID) Logout the current user, also happens automatically when a new user logs in (UID?)(UID! “username” 01) Display the current logged in user and their access level</p>	

Zoom Lens Position Adjustment (ZOM)	
<p>Adjust lens to specific zoom position with a specified direction (1, -1). NOTE: <i>This command can only be used to update the current ILS file. Changing the zoom for the current channel will change the zoom for any channel using the same ILS file.</i></p> <p>Use command without subcode:</p> <ul style="list-style-type: none"> • If ILS is ON, motor will move to specified steps and save data to the active channel. • If ILS is OFF, motor will move to specified steps, do not save data to the active channel. 	
SUBCODE	DESCRIPTION OF USE
BACN	Motor backlash in negative direction. Read-only.
BACP	Motor backlash in positive direction. Read-only.

Zoom Lens Position Adjustment (ZOM) (Continued)	
CALB	Calibrate travel range and backlash on specified. Only valid parameter for this command is 1. Set only command.
Cxxx	Replace xxx with the channel number. Valid range is 101-164.
NONE	Moving lens mount to a specified vertical position.
RNGN	Motor moving range in negative direction. Read-only.
RNGP	Motor moving range in positive direction. Read-only.
RSET	Move motor to the center flag then move back to current position. Only valid parameter for this command is 1. Set only command.
STRT	Start motor moving in specified direction, where direction can be (-1, 1). Write-only for v1.3 or newer.
STOP	Stops the motor. Write-only for v1.3 or newer.
MOVR	Moves the motor a given number of steps based on the current location. Write-only for v1.3 or newer.
<p>EXAMPLES: (ZOM 500 1) Move lens to position 500 with positive approach (ZOM 500 -1) Move lens to position -500 with negative approach (ZOM+C101 -500 1) Set lens zoom position for channel 1 to -500 with positive approach. (ZOM ?) Return current motor position (ZOM + CALB 1) Calibrate the zoom (ZOM + RSET 1) Reset the zoom (ZOM+STRT 1) Starts motor moving in positive direction (ZOM+STOP) Stops motor (ZOM+MOVR -100) Move motor 100 steps in negative direction (ZOM+MOVR 200) Move motor 200 steps in positive direction.</p>	



ASSY TECH DOCS CP4220

Corporate offices

USA – Cypress
ph: 714-236-8610
Canada – Kitchener
ph: 519-744-8005

Worldwide offices

United Kingdom
ph: +44 118 977 8000
France
ph: +33 (0) 1 41 21 00 36
Germany
ph: +49 2161 664540

Eastern Europe
ph: +36 (0) 1 47 48 100
Middle East
ph: +971 (0) 4 299 7575
Spain
ph: + 34 91 633 9990

Singapore
ph: +65 6877-8737
Beijing
ph: +86 10 6561 0240
Shanghai
ph: +86 21 6278 7708

Japan
ph: 81-3-3599-7481
South Korea
ph: +82 2 702 1601

